

Three-phase energy meter for transformer connection with serial S-Bus interface

Energy meters with an integrated S-Bus interface allow direct reading of all relevant data, such as energy (Total and partial), current and voltage for every phase and active and reactive power for every phase and for the three phases.

Main features

- 3-phase energy meter, 3 × 230 / 400 VAC 50 Hz
- Measurement through a current transformer up to 1500 A
- Display of active power, voltage and current for every phase
- Display of active power for all phase
- S-Bus Interface to query the data
- Reactive power for every and/or all Phase available through interface
- Up to 254 meter can be connected to the S-Bus Interface
- 7-digit display
- Lead seal possible with cap as accessory
- Accuracy class B according to EN50470-3, accuracy class 1 according to IEC62053-21

Order Number

Standard Version: AWD3D5WS00C2A00
 MID Version: AWD3D5WS00C3A00
 Sealing Caps: 4 104 7485 0

Technical data

Precision class	B according to EN50470-3, 1 according to IEC62053-21
Operating voltage	3 × 230 / 400VAC, 50 Hz Tolerance -20% / +15%
Power consumption	Active 0.4 W per phase
Counting range	00000.00 ... 99999.99 100000.0 ... 999999.9
Display	LCD backlit, digits 6 mm high
Display without mains power	Capacitor based LCD max. 2 times over 10 days



Mounting

Mounting	On 35 mm rail, according to EN60715TH35
Terminal connections main circuit	Conductor cross-section 1.5 – 16 mm ² , screwdriver Pozidrive no. 1, slot no.2, torque 1.5 – 2 Nm
Terminal connections control circuit	Conductor cross-section max. 2.5 mm ² , screwdriver Pozidrive no. 0, slot no.2, torque 0.8 Nm
Insulation characteristics	- 4 kV / 50 Hz test according to IEC62053-21 - 6 kV 1.2/50 μs surge voltage according to IEC62052-11 - 2 kV / 50 Hz test for interface according to IEC62053-21 - Device protection class II
Ambient temperature	-25°...+55 °C
Storage temperature	-30°...+85 °C
Environment	Mechanical M2 Electromagnetic E2
Relative humidity	75% without condensation
EMC/interference immunity	- Surge voltage according to IEC61000-4-5 at main circuit 4 kV at S-Bus interface 1 kV - Burst voltage according to IEC61000-4-4, at main circuit 4 kV at S-Bus interface 1 kV - ESD according to IEC61000-4-2, contact 8 kV, air 15 kV

CT measurement

		5...1500 A			
Reference/maximum current		$I_{ref} = 5 \text{ A}, I_{max} = 6 \text{ A}$			
Starting/minimum current		$I_{st} = 10 \text{ mA}, I_{min} = 0.05 \text{ A}$			
Converter ratio		5:5	50:5	100:5	150:5
		200:5	250:5	300:5	400:5
		500:5	600:5	750:5	1000:5
		1250:5	1500:5		
Pulses per kWh	LED	10 Imp/kWh			

Error indication

Example: connection error at L3

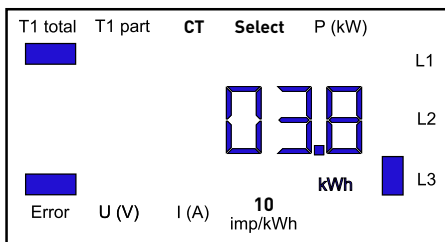

Example: connection error at L1 and L3

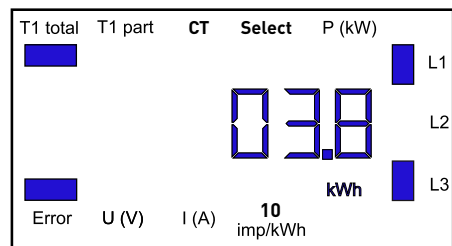

Dimensioned drawings

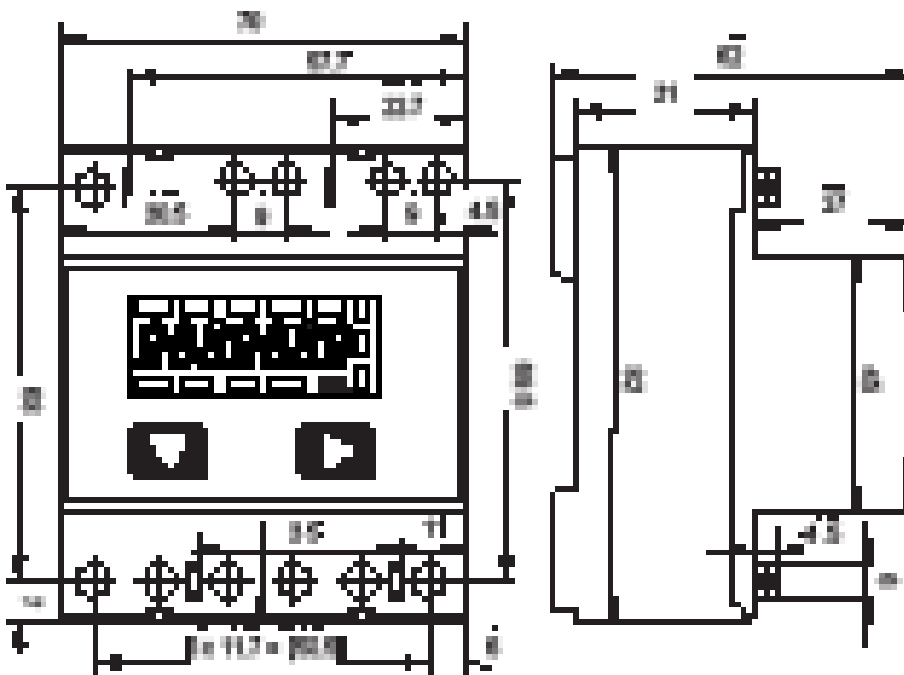

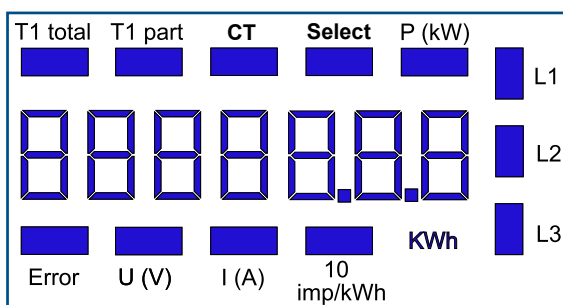

Display elements, direct measurement

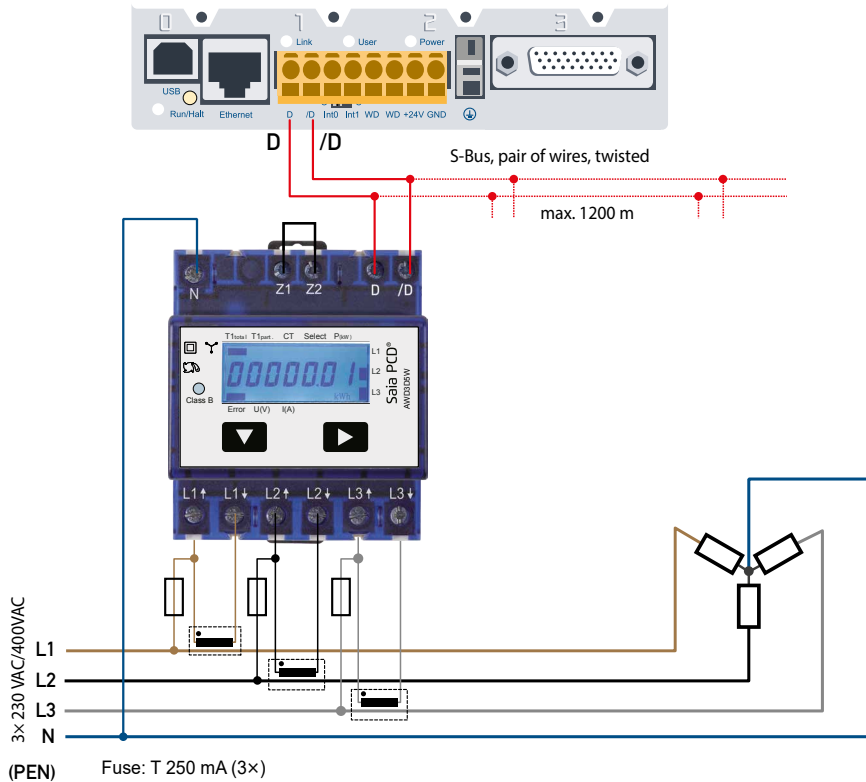

- ▶ T1 total Indicates total consumption
- ▶ T1 part Indicates partial consumption. This value can be reset
- ▶ CT Indicates the setting for the current transformer ratio
- ▶ Select When bridge Z1-Z2 is open, the transformer ratio can be adjusted under menu item: Select
- ▶ P (kW) Indicates the instantaneous output per phase or for all phases
- ▶ U (V) Indicates voltage per phase
- ▶ I (A) Indicates current per phase
- ▶ kWh Indicates the unit kWh for display of consumption (only for standard version)
- ▶ L1/L2/L3 Whenever the display shows P, U, I or Error, the corresponding phase will be indicated
- ▶ Error When phase is absent or current direction is wrong. The corresponding phase will also be indicated.

Wirings Diagram



 The secondary, mains current transformer connection has to be connected to the phase to be measured and therefore the transformer don't have to be grounded.

Technical data S-Bus

Bus system	S-Bus
Transmission rate	4800-96'00-19'200-38'400-57'600-115'200. The transmission Baud rate is automatically detected
Transmission mode	Data
Bus length (max.)	1200 m (without repeater)
Response time	Write: 60 ms Read: 60 ms

- ▶ The interface works only if the Phase 1 is connected.
- ▶ The communication is ready 30 s after the Power On
- ▶ The use of Energymeter in Bus with intensive communication could reduce the performance of the Bus
- ▶ Refresh Time for the Data is 10 s. For this reason one energy meter should be not polled faster as 10 s.
- ▶ 254 devices could be connected to the S-Bus. Over 128 devices, a repeater should be used.
- ▶ The interface don't have a terminal resistor, this should be provided external.
- ▶ For a description of the used registers please look at the Register Page.

Data transmission

- ▶ Only «read/write» register instructions are recognized.
- ▶ Only one register can be written at a time.
- ▶ The device will respond «NAK» if more than 1 register is written.
- ▶ Up to 10 Registers could be read at a time.
- ▶ The device will respond «NAK» if more than 10 registers are read.
- ▶ The device will not respond to any unknown query.
- ▶ The device has a voltage monitoring system. In case of voltage loss, registers are stored in EEPROM (transmission rate» etc.)

Change the S-Bus address direct on device

- ▶ To modify the S-Bus address, press 3 s on ▶ touch
- ▶ In menu, ▼ increase address by 10, ▶ increase by 1
- ▶ Once the address is selected wait for the root menu to come back

Menu to display the value on LCD

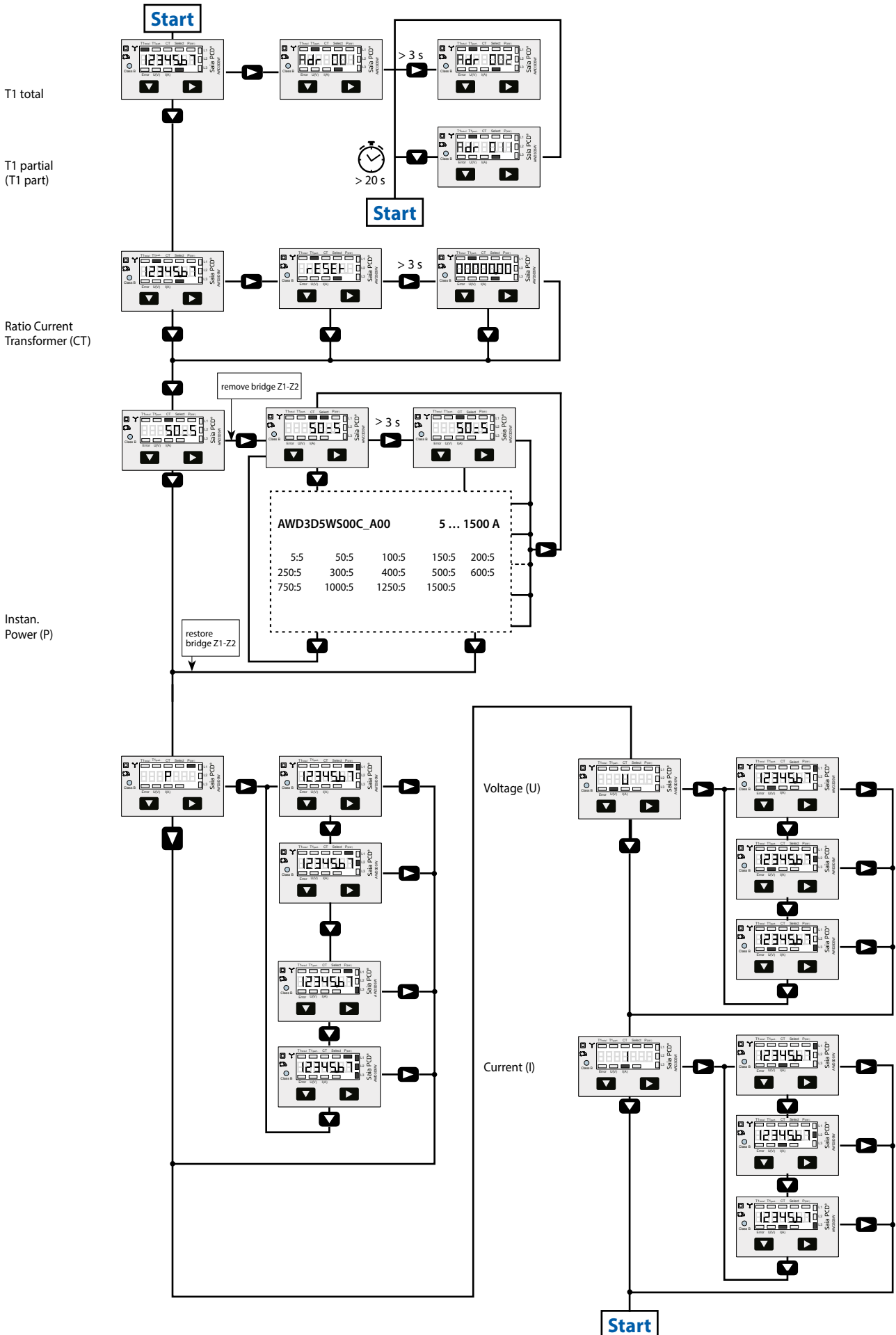

Register

The following Registers are available. For The pilot, different Register are not implemented and will give 0 as answer. All values are in HEX.

R	Read	Write	Description	Unit or Value
0	X		Firmware-Version	Ex: «11»= FW 1.1
1	X		Number of supported registers	will give «41»
2	X		Number of supported flags	will give «0»
3	X		Baudrate	BPS
4			Not used	will give a «0»
5	X		Type/ASN Funktion	will give «AWD3»
6	X		Type/ASN Funktion	will give «D5WS»
7	X		Type/ASN Funktion	will give «00Cx» x : 2 = non MID x : 3 = MID
8	X		Type/ASN Funktion	will give «A00»
9	X		HW Vers. Modif	Ex: «13»= HW 1.3
10			Not used	will give a «0»
11	X		Serial number	Serial number high
12	X		Serial numer	Serial number low
13			Not used	will give a «0»
14	X		Status	«0» = no Problem «1» = Problem with last communication request
15	X		S-Bus Timeout	ms
16	X	X	S-Bus Address	
17	X		Error Flags	0: No error 1: Error Phase 1 2: Error Phase 2 3: Error Phase 1 and 2 4: Error Phase 3 5: Error Phase 1 and 3 6: Error Phase 2 and 3 7: Error Phase 1, 2 and 3
18	X		Current transformer ratio	Ex: Transformer 100/5 give 20
19	X		Tariff flag	0 is Tariff 1 4 is Tariff 2
20	X		WT1 total Counter Energy Total Tarif 1	10 ¹ kWh. (multiplier 0,1) Ex: 00912351= 0091235,1 kWh
21	X	X	WT1 partial Counter Energy partial Tarif 1 Any value written reset the counter	10 ¹ kWh. (multiplier 0,1) Ex: 00912351= 0091235,1 kWh
22			Not used	will give a «0»
23			Not used	will give a «0»
24	X		URMS phase 1 Effective Voltage of Phase 1	V Ex: 230 = 230 V
25	X		IRMS phase 1 Effective Current of phase 1	A / Except. 5/5 = 10 ¹ A Ex: 145 = 145 A
26	X		PRMS phase 1 Effective active Power of phase 1	10 ¹ kW (multiplier 0,1) Ex: 1545 = 154,5 kW
27	X		QRMS phase 1 Effective reactive power of phase 1	10 ¹ kVAr (multiplier 0,1) Ex: 1545 = 154,5 kVAr
28	X		cos phi phase 1	10 ⁻² (multiplier 0.01) Ex: 67 = 0.67
29	X		URMS phase 2 Effective Voltage of Phase 2	V Ex: 230 = 230 V
30	X		IRMS phase 2 Effective Current of phase 2	A / Except. 5/5 = 10 ¹ A Ex: 145 = 145 A
31	X		PRMS phase 2 Effective active Power of phase 2	10 ¹ kW (multiplier 0,1) Ex: 1545 = 154,5 kW
32	X		QRMS phase 2 Effective reactive power of phase 2	10 ¹ kVAr (multiplier 0,1) Ex: 1545 = 154,5 kVAr
33	X		cos phi phase 2	10 ⁻² (multiplier 0.01) Ex: 67 = 0.67
34	X		URMS phase 3 Effective Voltage of Phase 3	V Ex: 230 = 230 V
35	X		IRMS phase 3 Effective Current of phase 3	A / Except. 5/5 = 10 ¹ A Ex: 145 = 145 A
36	X		PRMS phase 3 Effective active Power of phase 2	10 ¹ kW (multiplier 0,1) Ex: 1545 = 154,5 kW
37	X		QRMS phase 3 Effective reactive power of phase 3	10 ¹ kVAr (multiplier 0,1) Ex: 1545 = 154,5 kVAr
38	X		cos phi phase 3	10 ⁻² (multiplier 0.01) Ex: 67 = 0.67
39	X		PRMS total Effective active Power of all phase	10 ¹ kW (multiplier 0,1) Ex: 1545 = 154,5 kW
40	X		QRMS total Effective reactive power of all phase	10 ¹ kVAr (multiplier 0,1) Ex: 1545 = 154,5 kVAr

Accessories

Sealing cover for:

- Single-phase Saia PCD® energy meter AAE1
- 3-phase Saia PCD® energy meter ALE3, AWC3 and AWD3

2 units are recommended for contact protection on AAE1.

4 units are recommended for contact protection on ALE3, AWC3 and AWD3.

Order no.

4 104 7485 0



ALE3, AWC3 or AWD3
with sealing cover

Mounting frame for 3-ph energy meters
of the families ALE3/AWC3/AWD3

PMK-EEM400

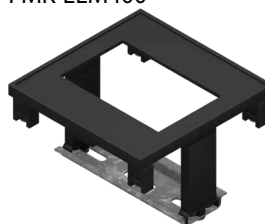

ALE3, AWC3 or AWD3
mounted in panel kit

Order details

Type	Short description	Description	Weight
AWD3D5WS00C3A00	Three-phase energy meters with integral serial S-Bus interface for current transformer (CT) measurement, 3x 230/400 VAC - 50 Hz	Three-phase energy meter with LCD display S-Bus interface, 5...1'500 A, 1 tariff display of active power, voltage and current according to MID directive	226 g
AWD3D5WS00C2A00	Three-phase energy meters with integral serial S-Bus interface for current transformer (CT) measurement, 3x 230/400 VAC - 50 Hz	Three-phase energy meter with LCD display S-Bus interface, 5...1'500 A, 1 tariff display of active power, voltage and current	226 g
4 104 7485 0	Accessories for energy meters	Lead sealing cap for energy meters AAE1, AAE3, ALE3 and AWD3	4 g
PMK-EEM400	Accessories for energy meters	Kit for mounting ALE3/AWD3 energy meters on door cabinet	

Saia-Burgess Controls AG

Bahnhofstrasse 18 | 3280 Murten, Switzerland
T +41 26 580 30 00 | F +41 26 580 34 99
www.saia-pcd.com

support@saia-pcd.com | www.sbc-support.com