

PCD1.G2100-A10

E-Line S-Serie RIO 8UI



The S-Serie E-Line RIO modules are controlled via the RS-485 serial communication protocols S-Bus and Modbus for decentralised automation using industrial quality components. The data point mix is specifically designed for building automation applications.

The compact design according to DIN 43880 enables the use in electrical distribution boxes even in the most confined spaces. Installation and maintenance are facilitated by the local manual override for each output. Remote maintenance is also possible using the access to the manual override by the web interface in the Saia PCD® controller. Programming is very efficient and fast using a complete FBox library with web templates for S-Bus. Individual programs may directly access the data points via Registers and Flags, a complete documentation is available from this data sheet.

Features

- S-Bus protocol optimized for fast data exchange
- Modbus protocol for integration in multi-vendor installations*
- Local override operating level via web panel or buttons on the module
- Easy programming using the FBox library and web templates
- Industrial hardware in accordance with IEC EN 61131-2
- Pluggable terminal blocks
- Bridge connectors for power supply and communication
- Bus termination on board
- Configurable Bi-Colour LEDs and labelling for I/Os

* By default the module is working in S-Bus Data Mode with Autobaud detection. To configure Modbus the Windows based Application "E-LineApp" is required.

General technical data

Power supply

Supply voltage	24 VDC, -15/+20% max. incl. 5% ripple (in accordance with EN/IEC 61131-2)
Power consumption	1.2 ... 3 W
Power supply bridge	24 VDC, 5 A max., up to 40 modules

Interfaces

Communications interface	RS-485 Baud rate: 9,600, 19,200, 38,400, 57,600, 115,200 bps (Autobauding) Micro USB, Type B
Address switch	Two rotary switches 0 ... 9 Address range 0 ... 98
Bus termination	Integrated switch to activate and inactivate resistor termination

General data

Ambient temperature	Operation: 0 ... +55 °C Storage: -40 ... +70 °C
Protection class	IP 20
Package	Single carton package with 1 Module incl. terminal blocks, 1 bridge connector

Dimensions and installation

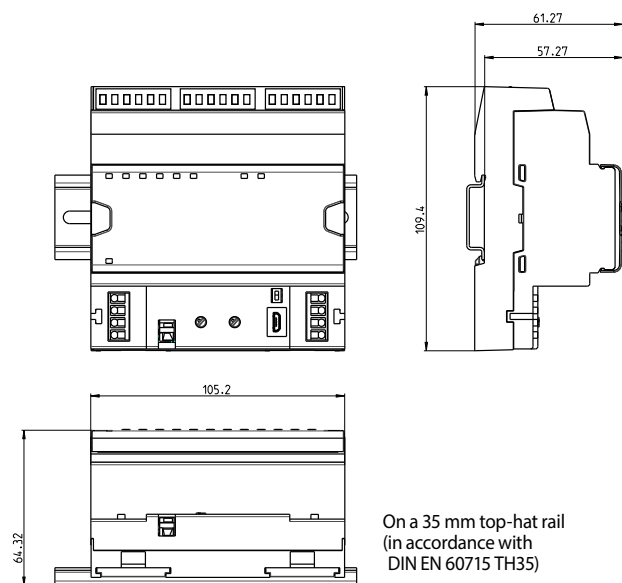

On a 35 mm top-hat rail (in accordance with DIN EN 60715 TH35)

Housing width 6 HP (105 mm)
Compatible with electrical control cabinet (in accordance with DIN 43880, size 2 x 55 mm)

Terminal technology

Push-in spring terminals enable wiring with rigid or flexible wires with a diameter up to 1.5 mm². A max. of 1 mm² is permitted with cable end sleeves.



Connection concept

For easy installation the power supply and communication bus is available together at one connector. The push-in spring terminals enable wiring as well support the connector bridge.

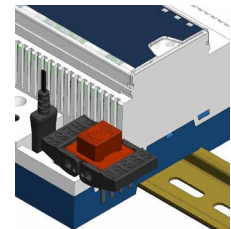
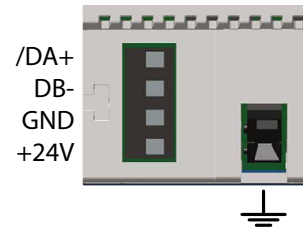

Bus termination

The module provides an active bus termination. It is switched off by factory default. To enable the termination, the switch need to be in the "Close" position.

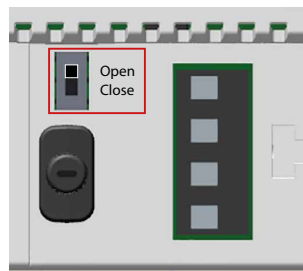

Status LED

OFF	No Power
Green	Communication OK
Green blink	Auto bauding in progress
Orange	No communication
Red	Error
Red/Green alternate	Booter mode (e.g. during Firmware download)
Red blink	Internal fatal error



Service interface

The USB interface provides access to the communication protocol configuration. Firmware updates can also be downloaded via Saia PG5[®] Firmware Download tool.

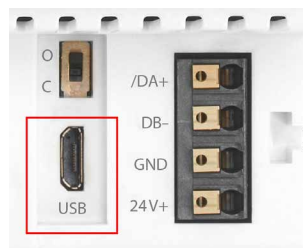

Reset button

Pushed over 20 seconds: The button needs to be pushed for minimum 20 seconds and released during the first minute after power up. All user settings are reset to factory default values.

Pushed at power up: Power off the device and press the button. Power on and release the button before 5 seconds have passed. The device stays in boot mode for further actions like firmware download etc.

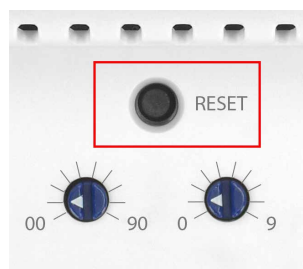

Assignment overview

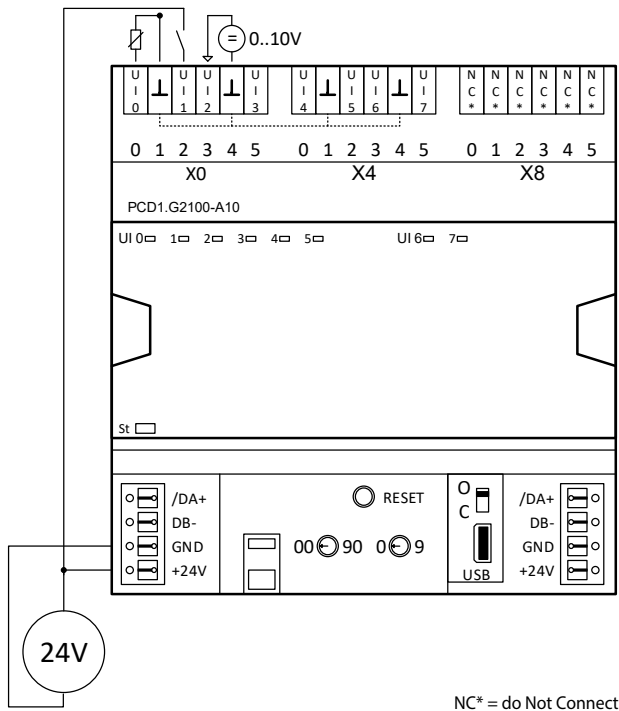

NC* = do Not Connect

LED Signalisation

Status LED

OFF	No Power
Green	Communication OK
Green blink	Auto bauding in progress
Orange	No communication
Red	Error
Red/Green alternate	Booter mode (e.g. during Firmware download)
Red blink	Internal fatal error

Universal input

I/O type	mode	OFF	GREEN	Blink (1Hz)
Analogue input	0 ... 10V	0 ... 325 mV	0.325 ... 10V	> 10V
	0 ... 2500 Ω	-	Value in range	>2k5 or open *
	0 ... 300 kΩ	-	Value in range	>300 kΩ or open *
	Pt1000	-	Value in range	< -50°C * > 400°C or open
	Ni1000	-	Value in range	< -50°C * > 210°C or open
	Ni1000LS	-	Value in range	< -30°C * > 140°C
	Digital	<5V	>10V	-



In case of error on analogue I/O (overflow), the LED will blink at 1 Hz.

Manual mode

The Manual override LED is Off in automatic mode and orange in case of manual override is active.

LED colour

- ▶ Off (automatic)
- ▶ Orange manual mode active

LED blink code

- ▶ No blink (local manual override)
- ▶ Blinking 1 flash per second (remote manual override)

Connection diagrams

Universal inputs

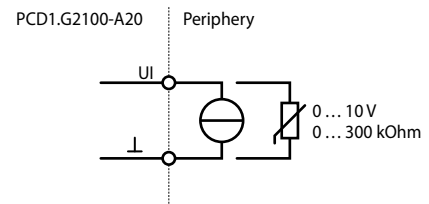

Power supply and bus termination

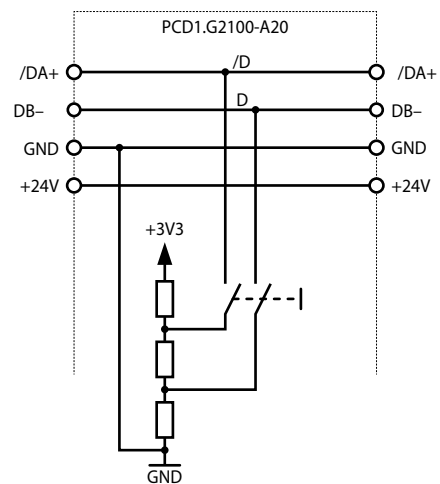

5

The modules are addressed and programmed with Saia PG5® FBoxes. Web templates are available for the operation and visualisation of the manual override function.

Fupla

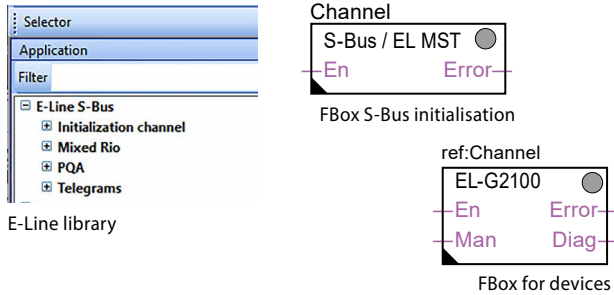

Communication FBox

- ▶ Data exchange for I/O via optimised S-Bus
- ▶ Configurable save state for bus interruption or timeout
- ▶ Direct generation of the symbols
- ▶ Reading and writing of the status of the manual override status
- ▶ Direct compatibility with web macros



Further information, including which FBoxes are supported, Getting Started, etc., can be found on our support page www.sbc-support.com.

Web templates

Web templates are available for the operation and visualisation of the manual override function.

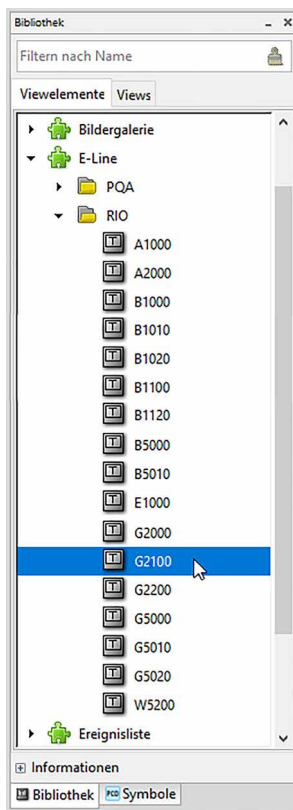

The inputs of the E-Line RIO modules can be addressed via the standard S-Bus. However the FBox from the E-Line library is used for the configuration of these modules. It is therefore recommended to use the optimised S-Bus protocol and the corresponding FBoxes from the E-Line library. Mixed mode operation is not recommended.

Manual operation



By using the local override function, commissioning can take place independently of the master station. In addition, the manual operation can also be controlled remotely using a touch panel. If the bus line is cut off, the module keeps the manually set values. Traditional manual operation in the control cabinet door via potentiometers and switches can therefore be completely replaced by this solution.

Five operating modes can be selected for the manual operating function:

Operating modes	Description	Operation	
		at the module	via remote communication
1	Manual operation deactivated	✗	✗
2	Operation permitted from the module only	✓	✗
3	Operation permitted from the module and limited operation from the panel. If manual operation is activated at the module, it cannot be reset from the panel.	✓	(conditional)
4	Unlimited operation from the panel and module	✓	✓
5	Panel operation (remote)	✗	✓





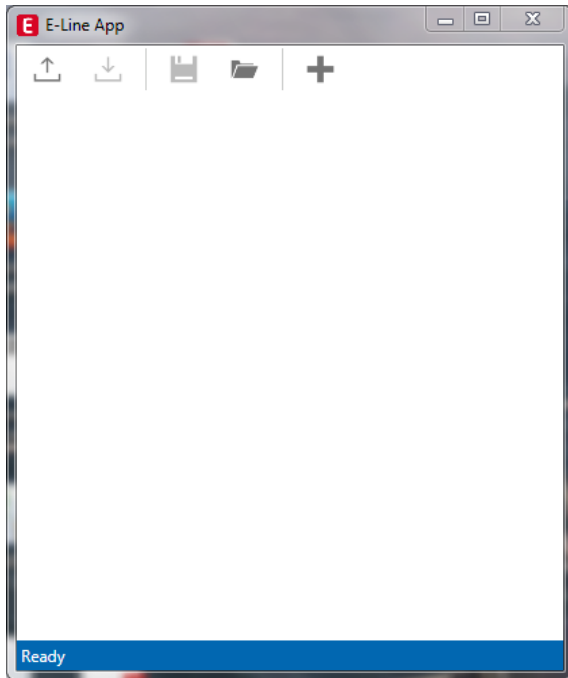

Depending on the application, reset of manually set values is allowed from a panel. To address this requirement, it is possible to deactivate or limit manual operation function.

E-line App device setup

E-Line RIOs support the device setup by a windows application program connected via USB. The installer is available for download from the SBC support page: www.sbc-support.com → E-Line RIO IO Modules.



-  Create a new device configuration
-  Open an existing device configuration
-  Save the current settings as device configuration
-  Upload configuration from the device
-  Download settings to the device

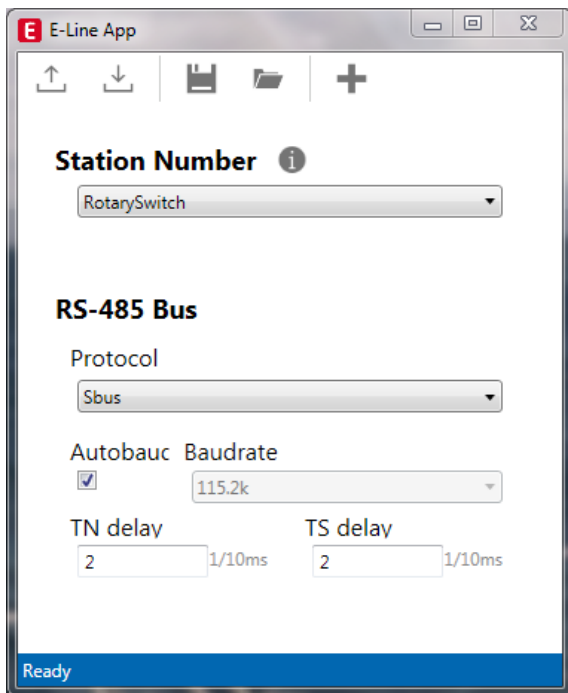

The station number can be set by the rotary switches at the device in the range of 0 ... 98. If the rotary switches are set to position 99 the station number can be defined by the device configuration in a range of 0 ... 253.

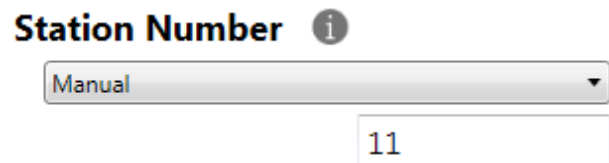

The serial communication protocol can be defined either as S-Bus or Modbus. By default the modules are delivered from factory with S-Bus.

RS-485 Bus

Protocol

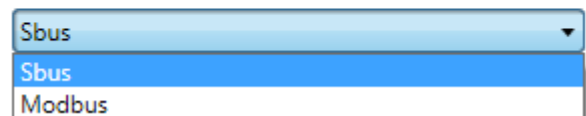

The Baudrate can be defined as automatic detection (default) or set to a specific value. The drop down choice will be available when the check box "Automatic" is unchecked. TN delay and TS delay shall be left at their default values of 2.

S-Bus settings

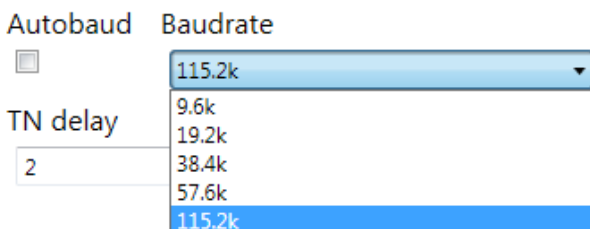

Modbus settings

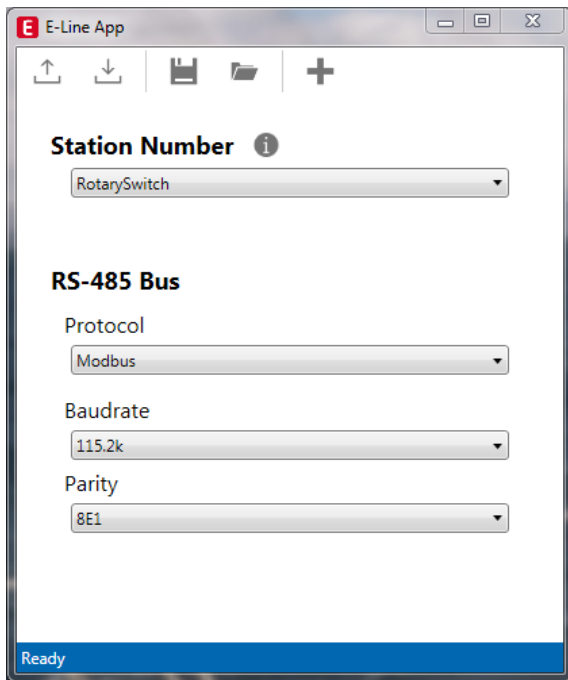

The Baudrate is set by default to 115 k. It can be defined as choice of the list.

Baudrate

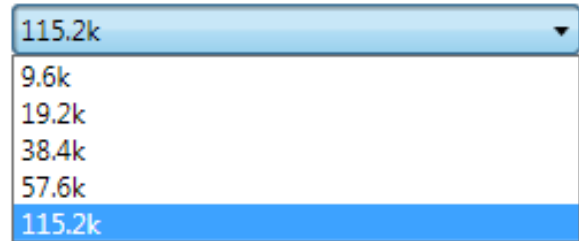

For best interoperability the Parity Mode and number of Stop Bits can also be set.

Parity

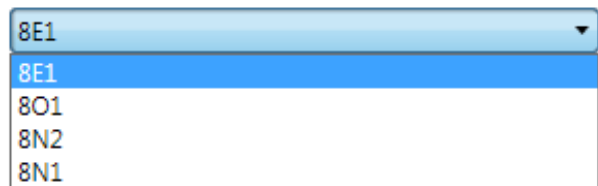

S-Bus communication

S-Bus communication is based on Saia PCD® S-Bus Data Mode. Only the set-up of a unique S-Bus address within the communication line is required to establish a communication between Saia PCD® controllers and E-Line RIO modules. The address can be set by the rotary switches at the front of the module. The baud rate will be learned from the network by factory default. In addition a Windows based application is available for manual parameter setup. Configuration parameters as well as manual override state and value are saved non-volatile. A delay of about one second between a manual state change and none volatile saving has to be taken into consideration.

Device address

- ▶ 0 ... 98 Address is taken from the rotary switches
- ▶ 99 Address is taken from the device configuration. The address is settable with the E-Line configuration software.

Start-up procedure

- ▶ Reboot: All outputs are cleared (Off state)
- ▶ < 1 sec. Output in manual operation are set according to the state before power down.
- ▶ Outputs in automatic mode
 - Is no telegram received after reboot within the “safe state power-on timeout” the module enters into the safe state mode and sets the outputs according to their configured values.
 - On reception of a valid command telegram the outputs are controlled by the communication. When no communication update followed within the “safe state com. timeout” the module enters into safe state and sets the outputs according to their configured values.

Usage of the E-Line module specific FBoxes

The usage of the E-Line module specific FBoxes from the E-Line S-Bus Fupla library allows an easy and efficient commissioning of the E-Line RIO.

The FBox allow to define and configure all possible functionalities of the E-Line RIO like manual override permission, usage of safe state mode, behaviour and colour of the LED's and so on.

In the background, the FBox does use the fast 'E-Line S-Bus' protocol for a high speed communication between the master and the RIO.

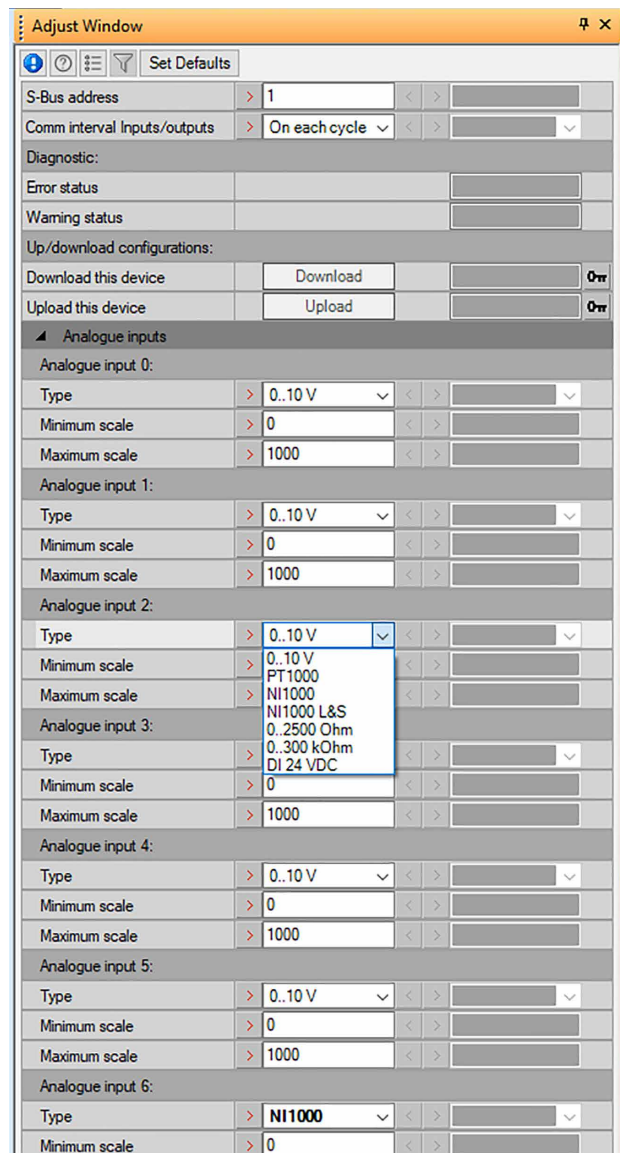
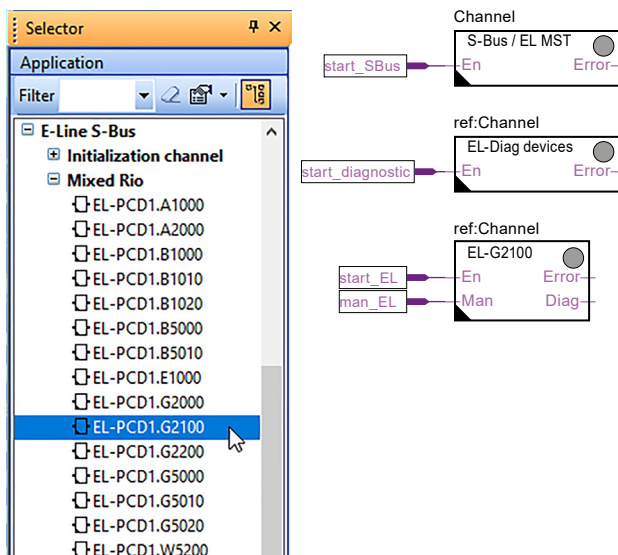

S-Bus communication

Direct access to the RIO medias with standard S-Bus send and receive telegrams

The following chapter describes the media and parameter mapping to Registers and Flags for individual programming. For efficient PCD programming the E-Line RIO FBox family and templates are suitable for most applications. Only individual programming (e.g. Instruction List) require standard S-Bus communication.

Analogue inputs

Input	Input Value	Read/Write	Mode	Range Min	Range Max	Read/Write
Analogue Input 0	Register 0	R	Register 360	Register 380	Register 400	RW
Analogue Input 1	Register 1	R	Register 361	Register 381	Register 401	RW
Analogue Input 2	Register 2	R	Register 362	Register 382	Register 402	RW
Analogue Input 3	Register 3	R	Register 363	Register 383	Register 403	RW
Analogue Input 4	Register 4	R	Register 364	Register 384	Register 404	RW
Analogue Input 5	Register 5	R	Register 365	Register 385	Register 405	RW
Analogue Input 6	Register 6	R	Register 366	Register 386	Register 406	RW
Analogue Input 7	Register 7	R	Register 367	Register 387	Register 407	RW

Mode Configuration Register:

0 : 0 ... 10 V (default)	Value scaled within Range Min and Range Max
3 : 0 ... 2500 Ω	Value scaled within Range Min and Range Max
4 : Pt1000	Value in 1/10°C (23.4 °C → 234)
5 : Ni1000	Value in 1/10°C (23.4 °C → 234)
6 : Ni1000LS	Value in 1/10°C (23.4 °C → 234)
8 : 0 ... 300 kΩ	Value scaled within Range Min and Range Max
9 : Digital input	Value for Input open, <5 V = 0, Input >10 V, 24 VDC = 1

Status	Status Value	Read/Write
Status AI0 ... AI3	Register 6	R
Status AI4 ... AI7	Register 7	R

Register format:
 1 byte for each analogue input status.
 (e.g. byte 0: AI0
 byte 1: AI1
 byte 2: AI2
 byte 3: AI3)
 Bit 0 Analogue input over-range
 Bit 1 Analogue input under-range
 Status is cleared when the input returns to normal state

Device Information

Firmware version (Decimal xyzz, 10802 → 1.08.02)	Register 600	R
Number of supported registers	Register 601	R
Number of supported flags	Register 602	R
Product type (ASCII String)***	Register 605 ... 608	R
Hardware version (Hex)	Register 609	R
Serial number (Hex)	Register 611 ... 612	R
Communication protocol (1:S-Bus Slave, 3:Modbus)	Register 620	R
Communication baud rate	Register 621	R
Communication auto baud enable (0:disabled, 1:enabled)	Register 622	R
Communication TN delay *	Register 623	R
Communication TS delay **	Register 624	R
Communication module address	Register 626	R

* Time in 0.1 ms (e.g. 2 means 200 us) before setting activation of RS-485 line driver send mode (only used for S-Bus slave protocol)
 ** Time in 0.1 ms (e.g. 2 means 200 us) before sending the first character after line driver activation (only used for S-Bus slave protocol)
 *** The four registers contain the ASCII characters of the product type.
 E.g. for PCD1.A2000-A20:
 0605: 50434431H 0606: 2E413230H 0607: 30302D41H 0608: 32300000H

Modbus communication

Modbus fulfils the requirements for standard communication protocols. It is based on Modbus RTU. The Windows based configuration software is required to enable and set up the Modbus communication parameters. The device address can be set up with the rotary switches at the front of the module. Configuration parameters as well as manual override state and value are saved non-volatile. A delay of about one second between a manual state change and non-volatile saving has to be taken into consideration.

Device address

- ▶ 0 ... 98 Address is taken from the rotary switches
- ▶ 99 Address is taken from the device configuration. The address is settable with the E-Line configuration software.

Start-up procedure

- ▶ Reboot: All outputs are cleared (Off state)
- ▶ <1 sec. Output in manual operation are set according to the state before power down.
- ▶ Outputs in automatic mode
 - Is no telegram received after reboot within the "safe state power-on timeout" the module enters as will into the safe state mode and sets the outputs according to their configured values.
 - On reception of a valid command telegram the outputs are controlled by the communication. When no communication update followed within the "safe state com. timeout" the module enters into safe state and sets the outputs according to their configured values.

The following chapter describes the media and parameter mapping to Registers and Flags (=Coils).

Supported Modbus services:

- ▶ Function code 1 (read outputs)
- ▶ Function code 3 (read registers)
- ▶ Function code 15 (write multiple outputs)
- ▶ Function code 16 (write multiple registers)

Read coils

Request							
Address	Function	Start Address		Number of coils to read		CRC	
0 ... 254	1	High-Byte	Low-Byte	High-Byte	Low-Byte	High-Byte	Low-Byte

Reply							
Address	Function	No. of Byte	Data			CRC	
0 ... 254	1	0 ... 256	Coil 0 ... 7	Coil 8 ... 15	...	High-Byte	Low-Byte

Write coils

Request										
Address	Function	Start Address		Number of Coils to write		Coil data			CRC	
0 ... 254	15	High-Byte	Low-Byte	High-Byte	Low-Byte	No. of Bytes	Coil 0 ... 7	...	High-Byte	Low-Byte

Reply							
Address	Function	Start Address		Number of written Coils		CRC	
0 ... 254	15	High-Byte	Low-Byte	High-Byte	Low-Byte	High-Byte	Low-Byte

Read register

Request							
Address	Function	Start Address		No. of Register to read		CRC	
0 ... 254	3	High-Byte	Low-Byte	High-Byte	Low-Byte	High-Byte	Low-Byte

Reply							
Address	Function	No. of Byte	Register Start Addr + 0	Addr + n	CRC		
0 ... 254	3	0 ... 256	High-Byte	Low-Byte	...	High-Byte	Low-Byte

Write register

Request											
Address	Function	Start Address		No. of Registers		No. of Bytes	Data Word: Start Addr + 0	Addr + n	CRC		
0 ... 254	16	High-Byte	Low-Byte	High-Byte	Low-Byte	2 ... 256	Low-Byte	High-Byte	...	High-Byte	Low-Byte

Reply							
Address	Function	Start Address		No of written Registers		CRC	
0 ... 254	16	High-Byte	Low-Byte	High-Byte	Low-Byte	High-Byte	Low-Byte

The CRC has to be calculated over all telegram bytes starting with address field up to the last data byte. The CRC has to be attached to the data. Please find an example at the appendix of this document. For more details, please refer the publicly available Modbus documentation www.modbus.org.

Modbus communication

Analogue inputs

Input	Input Value	Read/Write	Mode	Range Min	Range Max	Read/Write
Analogue Input 0	Register 0-1	R	Register 720-721	Register 760-761	Register 800-801	RW
Analogue Input 1	Register 2-3	R	Register 722-723	Register 762-763	Register 802-803	RW
Analogue Input 2	Register 4-5	R	Register 724-725	Register 764-765	Register 804-805	RW
Analogue Input 3	Register 6-7	R	Register 726-727	Register 766-767	Register 806-807	RW
Analogue Input 4	Register 8-9	R	Register 728-729	Register 768-769	Register 808-809	RW
Analogue Input 5	Register 10-11	R	Register 730-731	Register 770-771	Register 810-811	RW
Analogue Input 6	Register 12-13	R	Register 732-733	Register 772-773	Register 812-813	RW
Analogue Input 7	Register 14-15	R	Register 734-735	Register 774-775	Register 814-815	RW

Range registers are used in mode 0 ... 10 V, 0 ... 2500 Ω & 0 ... 300 kΩ

Mode Configuration Register:

0 : 0 ... 10 V (default)	Value scaled within Range Min and Range Max
3 : 0 ... 2500 Ω	Value scaled within Range Min and Range Max
4 : Pt1000	Value in 1/10°C (23.4 °C → 234)
5 : Ni1000	Value in 1/10°C (23.4 °C → 234)
6 : Ni1000LS	Value in 1/10°C (23.4 °C → 234)
8 : 0 ... 300 kΩ	Value scaled within Range Min and Range Max
9 : Digital input	Value for Input open, <5 V = 0, Input >10 V, 24 VDC = 1

Status	Status Value	Read/Write
Status AI0 ... AI3	Register 16-17	R
Status AI4 ... AI7	Register 18-19	R

Register format:
 1 byte for each analogue input status.
 (e.g. byte 0: AI0
 byte 1: AI1
 byte 2: AI2
 byte 3: AI3)
 Bit 0 Analogue input over-range
 Bit 1 Analogue input under-range
 Status is cleared when the input returns to normal state

Device Information

Firmware version (Decimal xxyzz, 10802 → 1.08.02)	Register 1200	R
Number of supported registers	Register 1202	R
Number of supported flags	Register 1204	R
Product type (ASCII String)*	Register 1210 ... 1217	R
Hardware version (Hex)	Register 1218	R
Serial number (Hex)	Register 1222 ... 1224	R
Communication protocol (1: S-Bus Slave, 3: Modbus)	Register 1240	R
Communication baud rate	Register 1242	R
Communication auto baud enable (0: disabled, 1: enabled)	Register 1244	R
Communication Mode 0: 8,E,1; 1: 8,O,1; 2: 8,N,2; 3: 8,N,1	Register 1250	R
Communication module address	Register 1252	R

*1 The eight registers contain the ASCII characters of the product type.
 E.g. for PCD1.A2000-A20:
 1210...1217: 5043H | 4431H | 2E41H | 3230H | 3030H | 2D41H | 3230H | 0000H

CRC Generation Example

(Source: http://modbus.org/docs/PI_MBUS_300.pdf, the following content of this page is copied from the referenced document. In case of any questions, please check out the original source)

The function takes two arguments: unsigned char *puchMsg; A pointer to the message buffer containing binary data to be used for generating the CRC unsigned short usDataLen; The quantity of bytes in the message buffer. The function returns the CRC as a type unsigned short.

CRC Generation Function

```
unsigned short CRC16(puchMsg, usDataLen) ;
unsigned char *puchMsg ;                               /* message to calculate CRC upon */
unsigned short usDataLen ;                             /* quantity of bytes in message */
{
    unsigned char uchCRCHi = 0xFF ;                    /* high byte of CRC initialized */
    unsigned char uchCRCLo = 0xFF ;                    /* low byte of CRC initialized */
    unsigned uIndex ;                                  /* will index into CRC lookup table */
    while (usDataLen--)>0                             /* pass through message buffer */
    {
        uIndex = uchCRCHi ^ *puchMsg++;                /* calculate the CRC */
        uchCRCHi = uchCRCLo ^ uchCRCHi[uIndex];
        uchCRCLo = uchCRCLo[uIndex];
    }
    return (uchCRCHi << 8 | uchCRCLo);
}
```

High-Order Byte Table

```
/* Table of CRC values for high-order byte */
static unsigned char auchCRCHi[] = {
0x00, 0xC1, 0x81, 0x40, 0x01, 0xC0, 0x80, 0x41, 0x01, 0xC0, 0x80, 0x41, 0x00, 0xC1, 0x81, 0x40,
0x01, 0xC0, 0x80, 0x41, 0x00, 0xC1, 0x81, 0x40, 0x00, 0xC1, 0x81, 0x40, 0x01, 0xC0, 0x80, 0x41,
0x01, 0xC0, 0x80, 0x41, 0x00, 0xC1, 0x81, 0x40, 0x00, 0xC1, 0x81, 0x40, 0x01, 0xC0, 0x80, 0x41,
0x00, 0xC1, 0x81, 0x40, 0x01, 0xC0, 0x80, 0x41, 0x01, 0xC0, 0x80, 0x41, 0x00, 0xC1, 0x81, 0x40,
0x01, 0xC0, 0x80, 0x41, 0x00, 0xC1, 0x81, 0x40, 0x01, 0xC0, 0x80, 0x41, 0x01, 0xC0, 0x80, 0x41,
0x00, 0xC1, 0x81, 0x40, 0x01, 0xC0, 0x80, 0x41, 0x01, 0xC0, 0x80, 0x41, 0x00, 0xC1, 0x81, 0x40,
0x01, 0xC0, 0x80, 0x41, 0x00, 0xC1, 0x81, 0x40, 0x00, 0xC1, 0x81, 0x40, 0x01, 0xC0, 0x80, 0x41,
0x01, 0xC0, 0x80, 0x41, 0x00, 0xC1, 0x81, 0x40, 0x00, 0xC1, 0x81, 0x40, 0x01, 0xC0, 0x80, 0x41,
0x00, 0xC1, 0x81, 0x40, 0x01, 0xC0, 0x80, 0x41, 0x01, 0xC0, 0x80, 0x41, 0x00, 0xC1, 0x81, 0x40,
0x01, 0xC0, 0x80, 0x41, 0x00, 0xC1, 0x81, 0x40, 0x01, 0xC0, 0x80, 0x41, 0x01, 0xC0, 0x80, 0x41,
0x00, 0xC1, 0x81, 0x40, 0x01, 0xC0, 0x80, 0x41, 0x01, 0xC0, 0x80, 0x41, 0x00, 0xC1, 0x81, 0x40,
0x01, 0xC0, 0x80, 0x41, 0x00, 0xC1, 0x81, 0x40, 0x01, 0xC0, 0x80, 0x41, 0x01, 0xC0, 0x80, 0x41,
0x00, 0xC1, 0x81, 0x40, 0x01, 0xC0, 0x80, 0x41, 0x01, 0xC0, 0x80, 0x41, 0x00, 0xC1, 0x81, 0x40 };
```

Low-Order Byte Table

```
/* Table of CRC values for low-order byte */
static char auchCRCLo[] = {
0x00, 0xC0, 0xC1, 0x01, 0xC3, 0x03, 0x02, 0xC2, 0xC6, 0x06, 0x07, 0xC7, 0x05, 0xC5, 0xC4, 0x04,
0xCC, 0x0C, 0x0D, 0xCD, 0x0F, 0xCF, 0xCE, 0x0E, 0x0A, 0xCA, 0xCB, 0x0B, 0xC9, 0x09, 0x08, 0xC8,
0xD8, 0x18, 0x19, 0xD9, 0x1B, 0xDB, 0xDA, 0x1A, 0x1E, 0xDE, 0xDF, 0x1F, 0xDD, 0x1D, 0x1C, 0xDC,
0x14, 0x04, 0x05, 0x15, 0x07, 0x17, 0x16, 0x06, 0xD2, 0x12, 0x13, 0x03, 0x11, 0x01, 0xD0, 0x10,
0xF0, 0x30, 0x31, 0xF1, 0x33, 0xF3, 0xF2, 0x32, 0x36, 0xF6, 0xF7, 0x37, 0xF5, 0x35, 0xF4, 0x34,
0x3C, 0xFC, 0xFD, 0x3D, 0xFF, 0x3F, 0x3E, 0xFE, 0xFA, 0x3A, 0x3B, 0xFB, 0x39, 0xF9, 0xF8, 0x38,
0x28, 0xE8, 0xE9, 0x29, 0xEB, 0x2B, 0x2A, 0xEA, 0xEE, 0x2E, 0x2F, 0xEF, 0x2D, 0xED, 0xEC, 0x2C,
0xE4, 0x24, 0x25, 0xE5, 0x27, 0xE7, 0xE6, 0x26, 0x22, 0xE2, 0xE3, 0x23, 0xE1, 0x21, 0x20, 0xE0,
0xA0, 0x60, 0x61, 0xA1, 0x63, 0xA3, 0xA2, 0x62, 0x66, 0xA6, 0xA7, 0x67, 0xA5, 0x65, 0x64, 0xA4,
0x6C, 0xAC, 0xAD, 0x6D, 0xAF, 0x6F, 0x6E, 0xAE, 0xAA, 0x6A, 0x6B, 0xAB, 0x69, 0xA9, 0xA8, 0x68,
0x78, 0xB8, 0xB9, 0x79, 0xBB, 0x7B, 0x7A, 0xBA, 0xBE, 0x7E, 0x7F, 0xBF, 0x7D, 0xBD, 0xBC, 0x7C,
0xB4, 0x74, 0x75, 0xB5, 0x77, 0xB7, 0xB6, 0x76, 0x72, 0xB2, 0xB3, 0x73, 0xB1, 0x71, 0x70, 0xB0,
0x50, 0x90, 0x91, 0x51, 0x93, 0x53, 0x52, 0x92, 0x96, 0x56, 0x57, 0x97, 0x55, 0x95, 0x94, 0x54,
0x9C, 0x5C, 0x5D, 0x9D, 0x5F, 0x9F, 0x9E, 0x5E, 0x5A, 0x9A, 0x9B, 0x5B, 0x99, 0x59, 0x58, 0x98,
0x88, 0x48, 0x49, 0x89, 0x4B, 0x8B, 0x8A, 0x4A, 0x4E, 0x8E, 0x8F, 0x4F, 0x8D, 0x4D, 0x4C, 0x8C,
0x44, 0x84, 0x85, 0x45, 0x87, 0x47, 0x46, 0x86, 0x82, 0x42, 0x83, 0x41, 0x81, 0x80, 0x40 };
```



ATTENTION

These devices must only be installed by a professional electrician, otherwise there is the risk of fire or the risk of an electric shock.



WARNING

Product is not intended to be used in safety critical applications, using it in safety critical applications is unsafe.



WARNING - Safety

The unit is not suitable for the explosion-proof areas and the areas of use excluded in EN 61010 Part 1.



WARNING - Safety

Check compliance with nominal voltage before commissioning the device (see type label). Check that connection cables are free from damage and that, when wiring up the device, they are not connected to voltage.



NOTE

In order to avoid moisture in the device due to condensate build-up, acclimatise the device at room temperature for about half an hour before connecting.



CLEANING

The device can be cleaned in dead state with a dry cloth or cloth soaked in soap solution. Do not use caustic or solvent-containing substances for cleaning.



MAINTENANCE

These devices are maintenance-free. If damaged during transportation or storage, no repairs should be undertaken by the user.



GUARANTEE

Opening the module invalidates the guarantee.



WEEE Directive 2012/19/EC Waste Electrical and Electronic Equipment directive

The product should not be disposed of with other household waste. Check for the nearest authorized collection centers or authorized recyclers. The correct disposal of end-of-life equipment will help prevent potential negative consequences for the environment and human health.



EAC Mark of Conformity for Machinery Exports to Russia, Kazakhstan or Belarus.



PCD1.G2100-A10

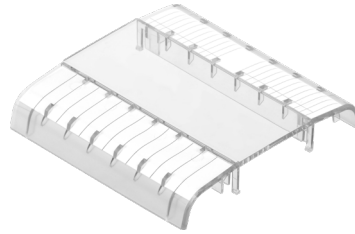

PCD1.K0206-005

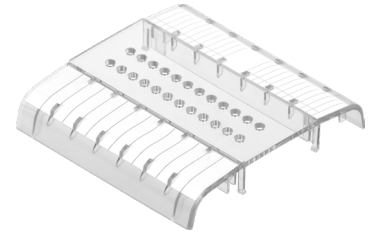

PCD1.K0206-025



Terminal set
32304321-003-S

Order details

Type	Short description	Description	Weight
PCD1.G2100-A10	E-Line S-Serie RIO 8UI	E-Line S-Serie combined input/output module manual override operating level for all outputs status LED for inputs and outputs supply 24 VDC 8 universal digital/analogue inputs - digital inputs 24 VDC - analogue inputs 12 bits 0...10 V, Pt/Ni 1000, Ni 1000 L&S, NTC, 0...2500 Ohm, 0...7500 Ohm, 0...300 kOhm 1 interface RS-485 (S-Bus and Modbus) 1 USB Service interface	210 g
PCD1.K0206-005	E-Line labelling set 5 × 6 HP*	E-Line cover and labelling set consisting of 5 × covers (6 HP = 105 mm) and labelling sheet for mounting in the automation control cabinet	365 g
PCD1.K0206-025	E-Line labelling set 5 × 6 HP* with holes	E-Line cover and labelling set with holes consisting of 5 × covers (6 HP = 105 mm) with holes for manual override operating level and labelling sheet for mounting in the automation control cabinet	365 g
32304321-003-S	Terminal set	6-pin terminal. Set of 6 terminal blocks	40 g

* Horizontal pitch: 1 HP corresponds to 17.5 mm

Saia-Burgess Controls AG

Bahnhofstrasse 18 | 3280 Murten, Switzerland
T +41 26 580 30 00 | F +41 26 580 34 99
www.saia-pcd.com

support@saia-pcd.com | www.sbc-support.com