

PCD1.W5200-A20

E-Line S-Serie RIO 8AO

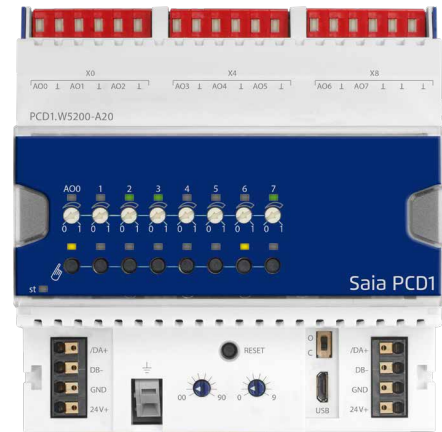

The S-Serie E-Line RIO modules are controlled via the RS-485 serial communication protocols S-Bus and Modbus for decentralised automation using industrial quality components. The data point mix is specifically designed for building automation applications.

The compact design according to DIN 43880 enables the use in electrical distribution boxes even in the most confined spaces. Installation and maintenance are facilitated by the local manual override for each output. Remote maintenance is also possible using the access to the manual override by the web interface in the Saia PCD® controller. Programming is very efficient and fast using a complete FBox library with web templates for S-Bus. Individual programs may directly access the data points via Registers and Flags, a complete documentation is available from this data sheet.

Features

- S-Bus protocol optimized for fast data exchange
- Modbus protocol for integration in multi-vendor installations*
- Local override operating level via web panel or buttons on the module
- Easy programming using the FBox library and web templates
- Industrial hardware in accordance with IEC EN 61131-2
- Pluggable terminal blocks
- Bridge connectors for power supply and communication
- Bus termination on board
- Configurable Bi-Colour LEDs and labelling for I/Os

* By default the module is working in S-Bus Data Mode with Autobaud detection. To configure Modbus the Windows based Application "E-LineApp" is required.

General technical data

Power supply

Supply voltage	24 VDC, -15/+20% max. incl. 5% ripple (in accordance with EN/IEC 61131-2)
Power consumption	1.2 ... 3 W
Power supply bridge	24 VDC, 5 A max., up to 40 modules

Interfaces

Communications interface	RS-485 Baud rate: 9,600, 19,200, 38,400, 57,600, 115,200 bps (Autobauding) Micro USB, Type B
Address switch	Two rotary switches 0 ... 9 Address range 0 ... 98
Bus termination	Integrated switch to activate and inactivate resistor termination

General data

Ambient temperature	Operation: 0 ... +55 °C Storage: -40 ... +70 °C
Protection class	IP 20
Package	Single carton package with 1 Module incl. terminal blocks, 1 bridge connector

Dimensions and installation

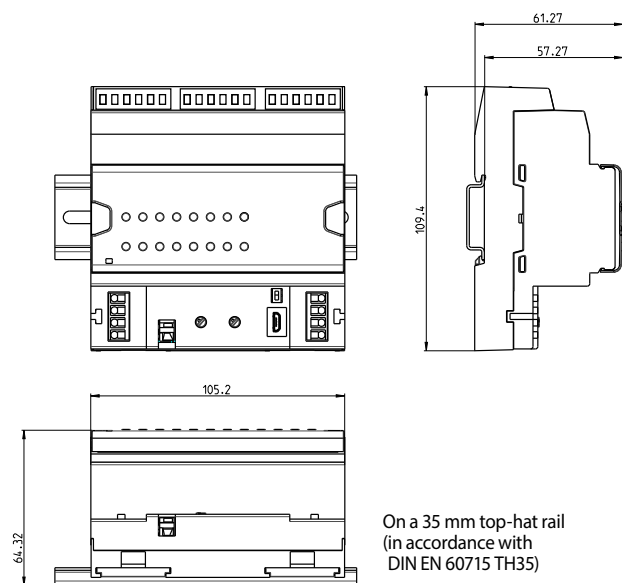

On a 35 mm top-hat rail (in accordance with DIN EN 60715 TH35)

Housing width 6 HP (105 mm)
Compatible with electrical control cabinet (in accordance with DIN 43880, size 2 x 55 mm)

Terminal technology

Push-in spring terminals enable wiring with rigid or flexible wires with a diameter up to 1.5 mm². A max. of 1 mm² is permitted with cable end sleeves.

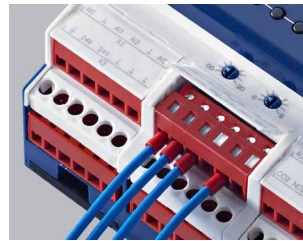

Connection concept

For easy installation the power supply and communication bus is available together at one connector. The push-in spring terminals enable wiring as well support the connector bridge.

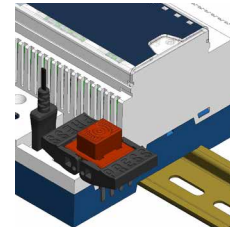
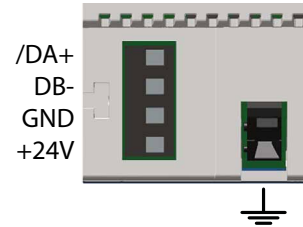

Bus termination

The module provides an active bus termination. It is switched off by factory default. To enable the termination, the switch need to be in the "Close" position.

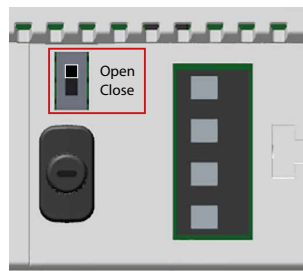

Status LED

OFF	No Power
Green	Communication OK
Green blink	Auto bauding in progress
Orange	No communication
Red	Error
Red/Green alternate	Booter mode (e.g. during Firmware download)
Red blink	Internal fatal error



Service interface

The USB interface provides access to the communication protocol configuration. Firmware updates can also be downloaded via Saia PG5[®] Firmware Download tool.

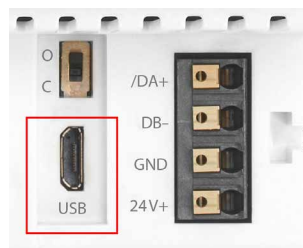

Reset button

Pushed over 20 seconds: The button needs to be pushed for minimum 20 seconds and released during the first minute after power up. All user settings are reset to factory default values.

Pushed at power up: Power off the device and press the button. Power on and release the button before 5 seconds have passed. The device stays in boot mode for further actions like firmware download etc.

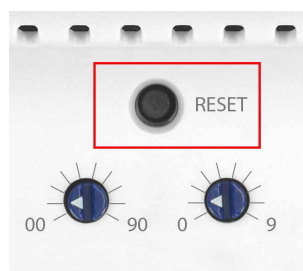

Output configuration

Analogue outputs		
Number	8	
Resolution	10 bit	
Signal range	0 ... 10V	
Protection	Short-circuit protection	
Resolution	9.77 mV	
Max. load at output	1 kΩ (10 mA @ 10 V)	
Accuracy (at T _{AMBIENT} = 25°C)	0.3% of the value ± 10 mV	
Residual ripple	< 15 mVpp	
Temperature error (0°C...+55°C)	+/- 0.2%	
Output delay	Channel update	1 ms (all channels are updated during this time)
	Time constant of hardware output filter	Voltage measurement τ = 2.5 ms
Manual operation	Local override operation by buttons	

Assignment overview

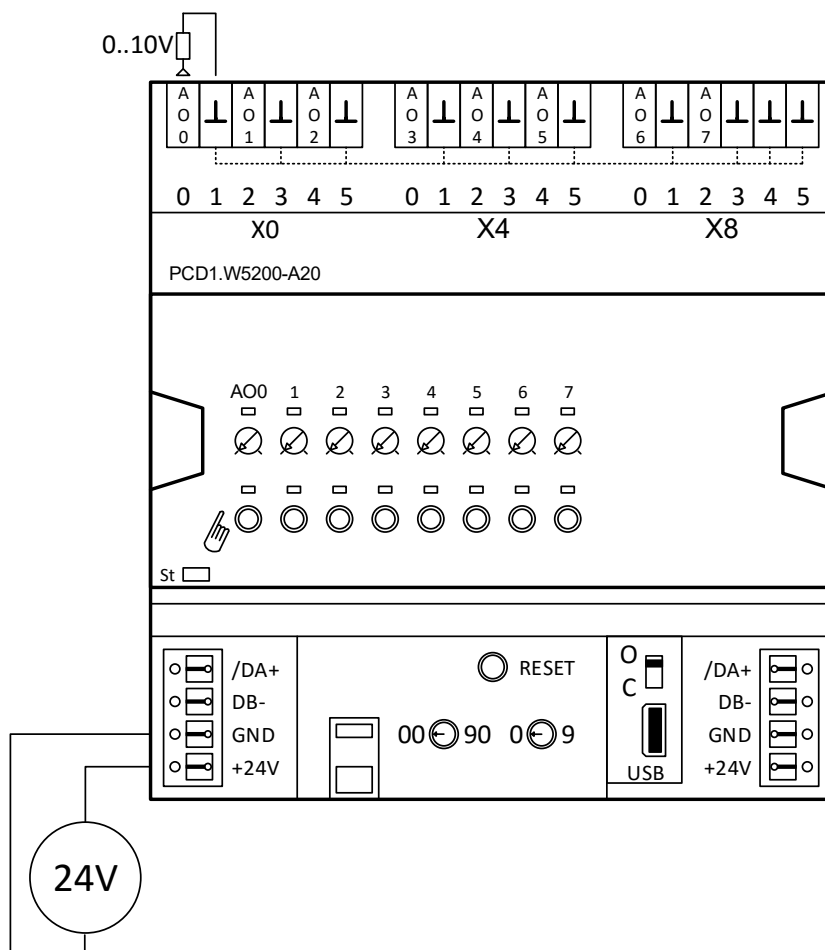

Connection diagrams

Analogue output

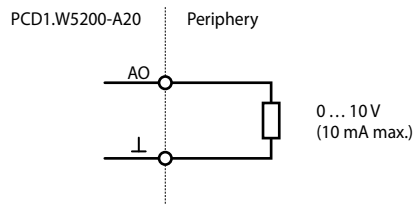

Power supply and bus termination

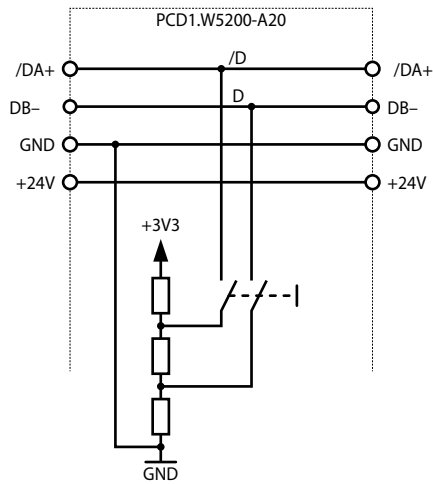

LED Signalisation

I/O type	mode	OFF	ON	Blink (1Hz)
Analogue output	-	0 ... 325 mV	0.325 ... 10 V	-

Status LED

OFF	No Power
Green	Communication OK
Green blink	Auto bauding in progress
Orange	No communication
Red	Error
Red/Green alternate	Booter mode (e.g. during Firmware download)
Red blink	Internal fatal error

Analog output

The Output indication LED depends on the output value.

- ▶ 0 V LED Off
- ▶ 1 ... 10 V LED Green

Manual mode

The Manual override LED is Off in automatic mode and orange in case of manual override is active.

LED colour

- ▶ Off (automatic)
- ▶ Orange manual mode active

LED blink code

- ▶ No blink (local manual override)
- ▶ Blinking 1 flash per second (remote manual override)

5

The modules are addressed and programmed with Saia PG5® Fupla FBoxes. Web templates are available for the operation and visualisation of the manual override function.

Fupla

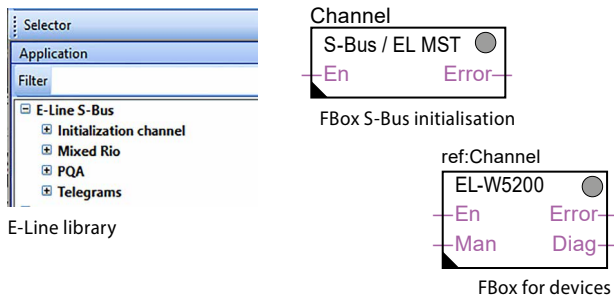

Communication FBox

- ▶ Data exchange for I/O via optimised S-Bus
- ▶ Configurable save state for bus interruption or timeout
- ▶ Direct generation of the symbols
- ▶ Reading and writing of the status of the manual override status
- ▶ Direct compatibility with web macros



Further information, including which FBoxes are supported, Getting Started, etc., can be found on our support page www.sbc-support.com.

Web templates

Web templates are available for the operation and visualisation of the manual override function.

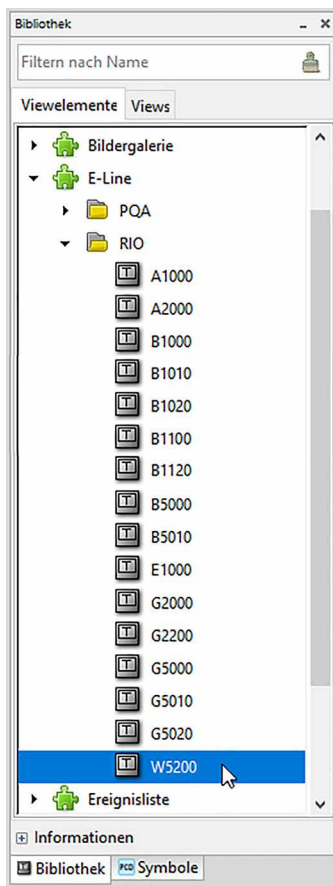

The inputs of the E-Line RIO modules can be addressed via the standard S-Bus. However the FBox from the E-Line library is used for the configuration of these modules. It is therefore recommended to use the optimised S-Bus protocol and the corresponding FBoxes from the E-Line library. Mixed mode operation is not recommended.

Manual operation

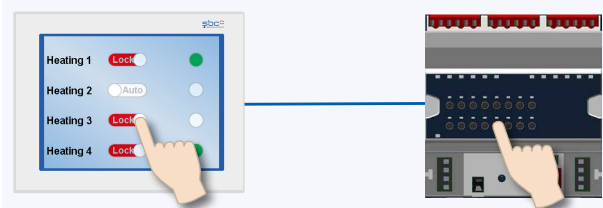

By using the local override function, commissioning can take place independently of the master station. In addition, the manual operation can also be controlled remotely using a touch panel. If the bus line is cut off, the module keeps the manually set values. Traditional manual operation in the control cabinet door via potentiometers and switches can therefore be completely replaced by this solution.

Five operating modes can be selected for the manual operating function:

Operating modes	Description	Operation	
		at the module	via remote communication
1	Manual operation deactivated	✗	✗
2	Operation permitted from the module only	✓	✗
3	Operation permitted from the module and limited operation from the panel. If manual operation is activated at the module, it cannot be reset from the panel.	✓	(conditional)
4	Unlimited operation from the panel and module	✓	✓
5	Panel operation (remote)	✗	✓





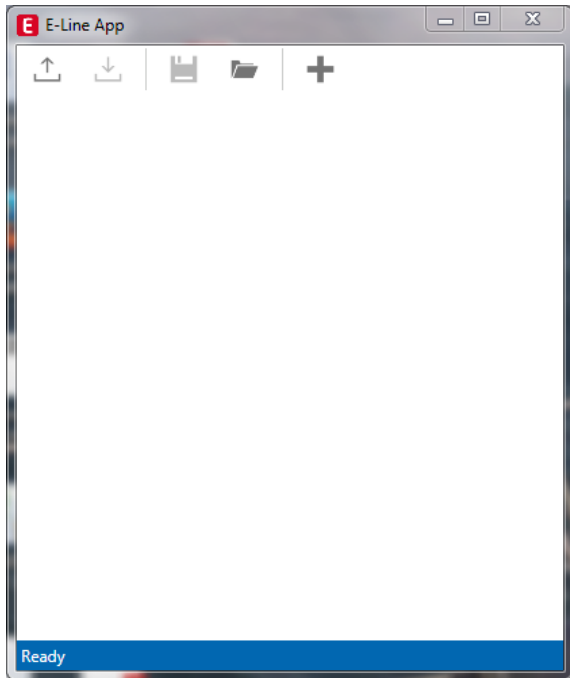

Depending on the application, reset of manually set values is allowed from a panel. To address this requirement, it is possible to deactivate or limit manual operation function.

E-line App device setup

E-Line RIOs support the device setup by a windows application program connected via USB. The installer is available for download from the SBC support page: www.sbc-support.com → E-Line RIO IO Modules.



-  Create a new device configuration
-  Open an existing device configuration
-  Save the current settings as device configuration
-  Upload configuration from the device
-  Download settings to the device

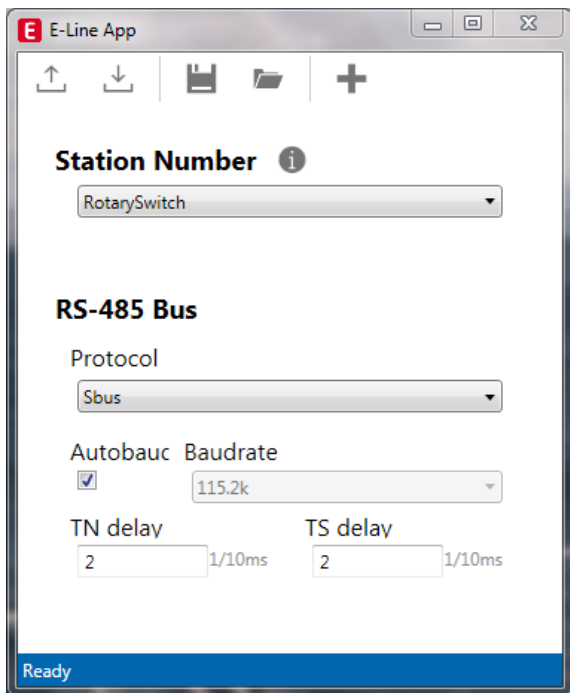

The station number can be set by the rotary switches at the device in the range of 0 ... 98. If the rotary switches are set to position 99 the station number can be defined by the device configuration in a range of 0 ... 253.

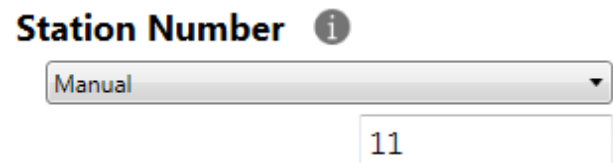
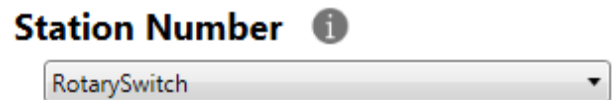

The serial communication protocol can be defined either as S-Bus or Modbus. By default the modules are delivered from factory with S-Bus.

RS-485 Bus

Protocol

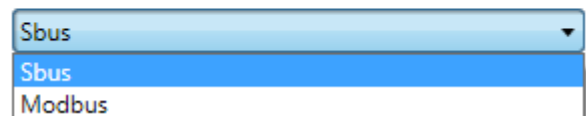

The Baudrate can be defined as automatic detection (default) or set to a specific value. The drop down choice will be available when the check box "Automatic" is unchecked. TN delay and TS delay shall be left at their default values of 2.

S-Bus settings

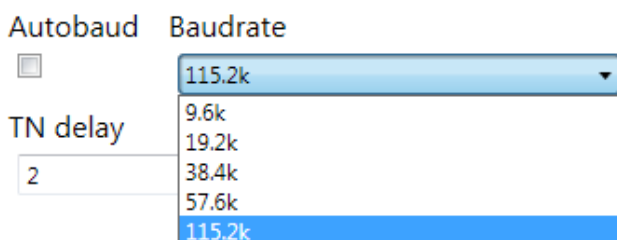

Modbus settings

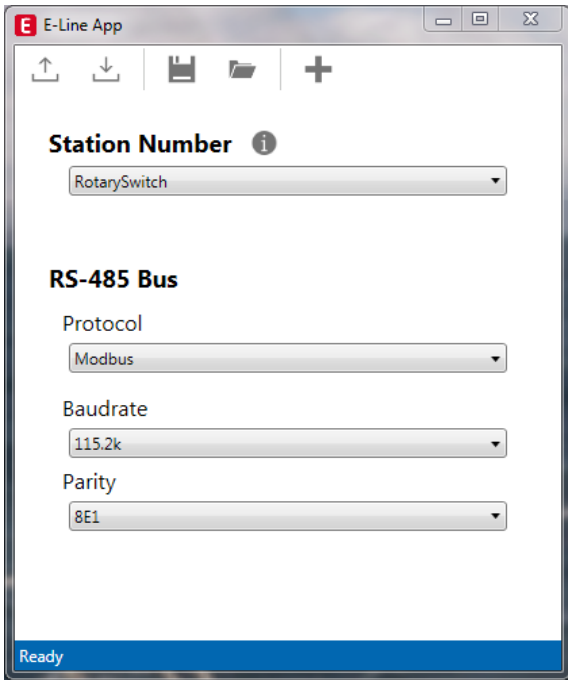

The Baudrate is set by default to 115 k. It can be defined as choice of the list.

Baudrate

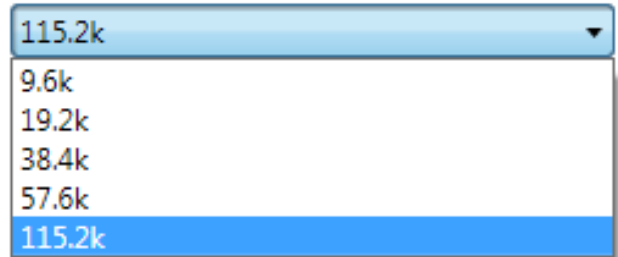

For best interoperability the Parity Mode and number of Stop Bits can also be set.

Parity

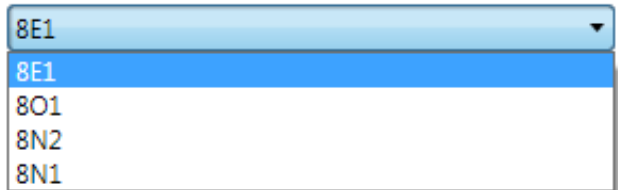

S-Bus communication

S-Bus communication is based on Saia PCD® S-Bus Data Mode. Only the set-up of a unique S-Bus address within the communication line is required to establish a communication between Saia PCD® controllers and E-Line RIO modules. The address can be set by the rotary switches at the front of the module. The baud rate will be learned from the network by factory default. In addition a Windows based application is available for manual parameter setup. Configuration parameters as well as manual override state and value are saved non-volatile. A delay of about one second between a manual state change and none volatile saving has to be taken into consideration.

Device address

- ▶ 0 ... 98 Address is taken from the rotary switches
- ▶ 99 Address is taken from the device configuration. The address is settable with the E-Line configuration software.

Start-up procedure

- ▶ Reboot: All outputs are cleared (Off state)
- ▶ < 1 sec. Output in manual operation are set according to the state before power down.
- ▶ Outputs in automatic mode
 - Is no telegram received after reboot within the “safe state power-on timeout” the module enters into the safe state mode and sets the outputs according to their configured values.
 - On reception of a valid command telegram the outputs are controlled by the communication. When no communication update followed within the “safe state com. timeout” the module enters into safe state and sets the outputs according to their configured values.

Usage of the E-Line module specific FBoxes

The usage of the E-Line module specific FBoxes from the E-Line S-Bus Fupla library allows an easy and efficient commissioning of the E-Line RIO.

The FBox allow to define and configure all possible functionalities of the E-Line RIO like manual override permission, usage of safe state mode, behaviour and colour of the LED's and so on.

In the background, the FBox does use the fast 'E-Line S-Bus' protocol for a high speed communication between the master and the RIO.

The image displays three parts of the software interface:

- Left Panel:** A tree view of the E-Line S-Bus configuration. It shows an 'Initialization channel' containing 'EL-S-Bus Master' and 'EL-Diagnostic devices', and a 'Mixed Rio' section listing various modules like EL-PCD1.A1000, EL-PCD1.A2000, EL-PCD1.B1000, EL-PCD1.B1010, EL-PCD1.B1020, EL-PCD1.B5000, EL-PCD1.E1000, EL-PCD1.G2000, EL-PCD1.G2200, EL-PCD1.G5000, EL-PCD1.G5010, EL-PCD1.G5020, and EL-PCD1.W5200.
- Middle Diagram:** A channel configuration diagram showing three 'ref.Channel' blocks. The first is 'S-Bus / EL MST' with 'start_SBus' connected to its 'En' input. The second is 'EL-Diag devices' with 'start_diagnostic' connected to its 'En' input. The third is 'EL-W5200' with 'start_EL' connected to its 'En' input and 'man_EL' connected to its 'Man' input.
- Right Panel:** The 'Properties' window for the 'FBox : EL-PCD1.W5200'. It contains a table of configuration parameters:

Adjust Variables	
S-Bus address	6
Comm interval Inputs/outputs	On each cycle
Comm interval manual override	On each cycle
Diagnostic:	
Up/download configurations:	
Manual value access	
Manual override permission	HW + S-Bus restricted
Safe state configurations:	
Global communication:	
Safe state enable.	Apply safe state
Safe state activation timeout	15.000
Power on:	
Safe state enable.	No safe state
Safe state power on timeout [30.000
Analogue outputs	
Analogue output 0:	
Safe state enable.	Apply safe state
Safe state value.	500
Minimum scale	0
Maximum scale	1000
Analogue output 1:	
Safe state enable.	No safe state
Safe state value.	0
Minimum scale	0
Maximum scale	1000
Analogue output 2:	
Safe state enable.	No safe state
Safe state value.	0
Minimum scale	0
Maximum scale	1000
Analogue output 3:	
Safe state enable.	No safe state
Safe state value.	0
Minimum scale	0
Maximum scale	1000
Analogue output 4:	
Safe state enable.	No safe state
Safe state value.	0
Minimum scale	0
Maximum scale	1000
Analogue output 5:	
Safe state enable.	No safe state
Safe state value.	0
Minimum scale	0

S-Bus communication

Direct access to the RIO media with standard S-Bus send and receive telegrams

The following chapter describes the media and parameter mapping to Registers and Flags for individual programming. For efficient PCD programming the E-Line RIO FBox family and templates are suitable for most applications. Only individual programming (e.g. Instruction List) require standard S-Bus communication.

Analogue Outputs

Output	Output value	Read/Write	Manual override Communication	Read/Write*	Manual override Local	Read/Write**
Analogue output 0	Register 50	RW	Register 90	RW	Register 98	RW
Analogue output 1	Register 51	RW	Register 91	RW	Register 99	RW
Analogue output 2	Register 52	RW	Register 92	RW	Register 100	RW
Analogue output 3	Register 53	RW	Register 93	RW	Register 101	RW
Analogue output 4	Register 54	RW	Register 94	RW	Register 102	RW
Analogue output 5	Register 55	RW	Register 95	RW	Register 103	RW
Analogue output 6	Register 56	RW	Register 96	RW	Register 104	RW
Analogue output 7	Register 57	RW	Register 97	RW	Register 105	RW

* Writable only if S-Bus permission is set in the configuration, otherwise write has no effect

** Writing to these registers has no effect. Used only if hardware permission is set in the configuration

Normal operation: The outputs are set according to the flag set by the communication.

Manual operation: The output are set according to the manual command, the communication flags are ignored.

Safe State: In case of a broken communication, a safe state value can be applied, see table Safe State Configuration.

Register format for manual override via S-Bus (Reg. 90...97):

Bit 0 Current output value

Bit 30 1: output is driven in manual override by S-Bus

Bit 31 1: output is driven in manual override by local push buttons

Register format for local manual override (Reg. 98...105):

Bit 0 Current output value

Bit 31 1: output is driven in manual override by local push buttons

Output	Range Min	Range Max.	Read/Write
Analogue output 0	Register 440	Register 460	RW
Analogue output 1	Register 441	Register 461	RW
Analogue output 2	Register 442	Register 462	RW
Analogue output 3	Register 443	Register 463	RW
Analogue output 4	Register 444	Register 464	RW
Analogue output 5	Register 445	Register 465	RW
Analogue output 6	Register 446	Register 466	RW
Analogue output 7	Register 447	Register 467	RW

S-Bus communication

Configuration for safe state and manual override

Output	Safe State Enable	Read/Write	Safe State Value	Read/Write
Analogue output 0	Flag 300	RW	Register 420	RW
Analogue output 1	Flag 301	RW	Register 421	RW
Analogue output 2	Flag 302	RW	Register 422	RW
Analogue output 3	Flag 303	RW	Register 423	RW
Analogue output 4	Flag 304	RW	Register 424	RW
Analogue output 5	Flag 305	RW	Register 425	RW
Analogue output 6	Flag 306	RW	Register 426	RW
Analogue output 7	Flag 307	RW	Register 427	RW
Communication safe state enable default 0 (disabled)			Flag 400	RW
Power-On safe state enable default 0 (disabled)			Flag 401	RW
Power-On safe state timeout [ms], Valid values 1000 ... 100.000.000, default 30.000			Register 590	RW
Communication safe state timeout [ms] Valid values 1000 ... 100.000.000, default 15.000			Register 591	RW
Manual operation mode Bit 0: Disabled Bit 1: Remote control limited*, default 1 Bit 2: Local operation enabled, default 1 Bit 3: Remote control unlimited*, default 0 Bits can be combined to enable remote and local operation			Register 592	RW

* If manual operation is locally activated at the module, the output value and manual state cannot be set/reset remotely

Manual operation mode:

- ▶ Disabled (0)
- ▶ Local operation only (4, Bit 2 set)
- ▶ Local operation enabled, remote limited (6, Bit 1 and 2 set), default
- ▶ Local and remote operation enabled (12, Bit 2 and 3 set)
- ▶ Remote operation only, local operation disabled (8, Bit 3 set)

The safe state enable flag and the safe state value are combined in the following way:

- Setting the enable flag to 0 keep the output value unchanged in case of safe state occurrence.
- Setting the enable flag to 1 writes the safe state value in case of safe state occurrence.

Device Information

Firmware version (Decimal x.yzzz, 10802 → 1.08.02)	Register 600	R
Number of supported registers	Register 601	R
Number of supported flags	Register 602	R
Product type (ASCII String)***	Register 605 ... 608	R
Hardware version (Hex)	Register 609	R
Serial number (Hex)	Register 611 ... 612	R
Communication protocol (1:S-Bus Slave, 3:Modbus)	Register 620	R
Communication baud rate	Register 621	R
Communication auto baud enable (0:disabled, 1:enabled)	Register 622	R
Communication TN delay *	Register 623	R
Communication TS delay **	Register 624	R
Communication module address	Register 626	R

* Time in 0.1 ms (e.g. 2 means 200 us) before setting activation of RS-485 line driver send mode (only used for S-Bus slave protocol)

** Time in 0.1 ms (e.g. 2 means 200 us) before sending the first character after line driver activation (only used for S-Bus slave protocol)

*** The four registers contain the ASCII characters of the product type.

E.g. for PCD1.A2000-A20:

0605: 50434431H 0606: 2E413230H 0607: 30302D41H 0608: 32300000H

Modbus communication

Modbus fulfils the requirements for standard communication protocols. It is based on Modbus RTU. The Windows based configuration software is required to enable and set up the Modbus communication parameters. The device address can be set up with the rotary switches at the front of the module. Configuration parameters as well as manual override state and value are saved non-volatile. A delay of about one second between a manual state change and non-volatile saving has to be taken into consideration.

Device address

- ▶ 0 ... 98 Address is taken from the rotary switches
- ▶ 99 Address is taken from the device configuration. The address is settable with the E-Line configuration software.

Start-up procedure

- ▶ Reboot: All outputs are cleared (Off state)
- ▶ <1 sec. Output in manual operation are set according to the state before power down.
- ▶ Outputs in automatic mode
 - Is no telegram received after reboot within the "safe state power-on timeout" the module enters as will into the safe state mode and sets the outputs according to their configured values.
 - On reception of a valid command telegram the outputs are controlled by the communication. When no communication update followed within the "safe state com. timeout" the module enters into safe state and sets the outputs according to their configured values.

The following chapter describes the media and parameter mapping to Registers and Flags (=Coils).

Supported Modbus services:

- ▶ Function code 1 (read outputs)
- ▶ Function code 3 (read registers)
- ▶ Function code 15 (write multiple outputs)
- ▶ Function code 16 (write multiple registers)

Read coils

Request							
Address	Function	Start Address		Number of coils to read		CRC	
0 ... 254	1	High-Byte	Low-Byte	High-Byte	Low-Byte	High-Byte	Low-Byte

Reply							
Address	Function	No. of Byte	Data			CRC	
0 ... 254	1	0 ... 256	Coil 0 ... 7	Coil 8 ... 15	...	High-Byte	Low-Byte

Write coils

Request										
Address	Function	Start Address		Number of Coils to write		Coil data			CRC	
0 ... 254	15	High-Byte	Low-Byte	High-Byte	Low-Byte	No. of Bytes	Coil 0 ... 7	...	High-Byte	Low-Byte

Reply							
Address	Function	Start Address		Number of written Coils		CRC	
0 ... 254	15	High-Byte	Low-Byte	High-Byte	Low-Byte	High-Byte	Low-Byte

Read register

Request							
Address	Function	Start Address		No. of Register to read		CRC	
0 ... 254	3	High-Byte	Low-Byte	High-Byte	Low-Byte	High-Byte	Low-Byte

Reply							
Address	Function	No. of Byte	Register Start Addr + 0	Addr + n	CRC		
0 ... 254	3	0 ... 256	High-Byte	Low-Byte	...	High-Byte	Low-Byte

Write register

Request											
Address	Function	Start Address		No. of Registers		No. of Bytes	Data Word: Start Addr + 0	Addr + n	CRC		
0 ... 254	16	High-Byte	Low-Byte	High-Byte	Low-Byte	2 ... 256	Low-Byte	High-Byte	...	High-Byte	Low-Byte

Reply							
Address	Function	Start Address		No of written Registers		CRC	
0 ... 254	16	High-Byte	Low-Byte	High-Byte	Low-Byte	High-Byte	Low-Byte

The CRC has to be calculated over all telegram bytes starting with address field up to the last data byte. The CRC has to be attached to the data. Please find an example at the appendix of this document. For more details, please refer the publicly available Modbus documentation www.modbus.org.

Modbus communication

Analogue Outputs

Output	Output Value	Read/Write	Manual override Communication	Read/Write*	Manual override Local	Read/Write**
Analogue output 0	Register 100-101	RW	Register 180-181	RW	Register 196-197	RW
Analogue output 1	Register 102-103	RW	Register 182-183	RW	Register 198-199	RW
Analogue output 2	Register 104-105	RW	Register 184-185	RW	Register 200-201	RW
Analogue output 3	Register 106-107	RW	Register 186-187	RW	Register 202-203	RW
Analogue output 4	Register 108-109	RW	Register 188-189	RW	Register 204-205	RW
Analogue output 5	Register 110-111	RW	Register 190-191	RW	Register 206-207	RW
Analogue output 6	Register 112-113	RW	Register 192-193	RW	Register 208-209	RW
Analogue output 7	Register 114-115	RW	Register 194-195	RW	Register 210-211	RW

* Writable only if S-Bus permission is set in the configuration, otherwise write has no effect

**Writing to these registers has no effect. Used only if hardware permission is set in the configuration

Normal operation: The outputs are set according the flag set by the communication.

Manual operation: The output are set according to the manual command, the communication flags are ignored.

Safe State: In case of a broken communication, a safe state value can be applied, see table Safe State Configuration.

Register format for manual override via Modbus (Reg. 180 ... 195):

Bit 0 Current output value

Enable Reg. Bit 14 1: output is driven in manual override by Modbus

Enable Reg. Bit 15 1: output is driven in manual override by local push buttons

Register format for local manual override (Reg. 196 ... 211):

Value Reg. Bit 0 Current output value

Enable Reg. Bit 15 1: output is driven in manual override by local push buttons

Output	Range Min	Range Max.	Read/Write
Analogue output 0	Register 880-881	Register 920-921	RW
Analogue output 1	Register 882-883	Register 922-923	RW
Analogue output 2	Register 884-885	Register 924-925	RW
Analogue output 3	Register 886-887	Register 926-927	RW
Analogue output 4	Register 888-889	Register 928-929	RW
Analogue output 5	Register 890-891	Register 930-931	RW
Analogue output 6	Register 892-893	Register 932-933	RW
Analogue output 7	Register 894-895	Register 934-935	RW

Modbus communication

Configuration for safe state and manual override

Output	Safe State Enable	Read/Write	Safe State Value	Read/Write
Analogue Output 0	Flag 300	RW	Register 840-841	RW
Analogue Output 1	Flag 301	RW	Register 842-843	RW
Analogue Output 2	Flag 302	RW	Register 844-845	RW
Analogue Output 3	Flag 303	RW	Register 846-847	RW
Analogue Output 4	Flag 304	RW	Register 848-849	RW
Analogue Output 5	Flag 305	RW	Register 850-851	RW
Analogue Output 6	Flag 306	RW	Register 852-853	RW
Analogue Output 7	Flag 307	RW	Register 854-855	RW
Communication safe state enable default 0 (disabled)			Flag 400	RW
Power-On safe state enable default 0 (disabled)			Flag 401	RW
Power-On safe state timeout [ms], Valid values 1000 ... 100.000.000, default 30.000			Reg. 1180, 1181	RW
Communication safe state timeout [ms] Valid values 1000 ... 100.000.000, default 15.000			Reg. 1182, 1183	RW
Manual operation mode Bit 0: Disabled Bit 1: Remote control limited*, default 1 Bit 2: Local operation enabled, default 1 Bit 3: Remote control unlimited*, default 0 Bits can be combined to enable remote and local operation			Register 1184	RW

* If manual operation is locally activated at the module, the output value and manual state cannot be set/reset remotely

Manual operation mode:

- ▶ Disabled (0)
- ▶ Local operation only (4, Bit 2 set)
- ▶ Local operation enabled, remote limited (6, Bit 1 and 2 set), default
- ▶ Local and remote operation enabled (12, Bit 2 and 3 set)
- ▶ Remote operation only, local operation disabled (8, Bit 3 set)

The safe state enable flag and the safe state value are combined in the following way:

- Setting the enable flag to 0 keep the output value unchanged in case of safe state occurrence.
- Setting the enable flag to 1 writes the safe state value in case of safe state occurrence.

Device Information

Firmware version (Decimal xyzzyz, 10802 → 1.08.02)	Register 1200	R
Number of supported registers	Register 1202	R
Number of supported flags	Register 1204	R
Product type (ASCII String)*	Register 1210 ... 1217	R
Hardware version (Hex)	Register 1218	R
Serial number (Hex)	Register 1222 ... 1224	R
Communication protocol (1: S-Bus Slave, 3: Modbus)	Register 1240	R
Communication baud rate	Register 1242	R
Communication auto baud enable (0:disabled, 1:enabled)	Register 1244	R
Communication Mode 0: 8,E,1; 1: 8,O,1; 2: 8,N,2; 3: 8,N,1	Register 1250	R
Communication module address	Register 1252	R

* The eight registers contain the ASCII characters of the product type.
E.g. for PCD1.A2000-A20:
1210...1217: 5043H | 4431H | 2E41H | 3230H | 3030H | 2D41H | 3230H | 0000H

CRC Generation Example

(Source: http://modbus.org/docs/PI_MBUS_300.pdf, the following content of this page is copied from the referenced document. In case of any questions, please check out the original source)

The function takes two arguments: unsigned char *puchMsg; A pointer to the message buffer containing binary data to be used for generating the CRC unsigned short usDataLen; The quantity of bytes in the message buffer. The function returns the CRC as a type unsigned short.

CRC Generation Function

```
unsigned short CRC16(puchMsg, usDataLen) ;
unsigned char *puchMsg ;                               /* message to calculate CRC upon */
unsigned short usDataLen ;                             /* quantity of bytes in message */
{
    unsigned char uchCRCHi = 0xFF ;                   /* high byte of CRC initialized */
    unsigned char uchCRCLo = 0xFF ;                   /* low byte of CRC initialized */
    unsigned uIndex ;                                  /* will index into CRC lookup table */
    while (usDataLen--)>0                             /* pass through message buffer */
    {
        uIndex = uchCRCHi ^ *puchMsg++;              /* calculate the CRC */
        uchCRCHi = uchCRCLo ^ auchCRCHi[uIndex];
        uchCRCLo = auchCRCLo[uIndex];
    }
    return (uchCRCHi << 8 | uchCRCLo);
}
```

High-Order Byte Table

```
/* Table of CRC values for high-order byte */
static unsigned char auchCRCHi[] = {
0x00, 0xC1, 0x81, 0x40, 0x01, 0xC0, 0x80, 0x41, 0x01, 0xC0, 0x80, 0x41, 0x00, 0xC1, 0x81, 0x40,
0x01, 0xC0, 0x80, 0x41, 0x00, 0xC1, 0x81, 0x40, 0x00, 0xC1, 0x81, 0x40, 0x01, 0xC0, 0x80, 0x41,
0x01, 0xC0, 0x80, 0x41, 0x00, 0xC1, 0x81, 0x40, 0x00, 0xC1, 0x81, 0x40, 0x01, 0xC0, 0x80, 0x41,
0x00, 0xC1, 0x81, 0x40, 0x01, 0xC0, 0x80, 0x41, 0x01, 0xC0, 0x80, 0x41, 0x00, 0xC1, 0x81, 0x40,
0x01, 0xC0, 0x80, 0x41, 0x00, 0xC1, 0x81, 0x40, 0x01, 0xC0, 0x80, 0x41, 0x01, 0xC0, 0x80, 0x41,
0x00, 0xC1, 0x81, 0x40, 0x01, 0xC0, 0x80, 0x41, 0x01, 0xC0, 0x80, 0x41, 0x00, 0xC1, 0x81, 0x40,
0x01, 0xC0, 0x80, 0x41, 0x00, 0xC1, 0x81, 0x40, 0x00, 0xC1, 0x81, 0x40, 0x01, 0xC0, 0x80, 0x41,
0x01, 0xC0, 0x80, 0x41, 0x00, 0xC1, 0x81, 0x40, 0x00, 0xC1, 0x81, 0x40, 0x01, 0xC0, 0x80, 0x41,
0x01, 0xC0, 0x80, 0x41, 0x00, 0xC1, 0x81, 0x40, 0x01, 0xC0, 0x80, 0x41, 0x00, 0xC1, 0x81, 0x40,
0x00, 0xC1, 0x81, 0x40, 0x01, 0xC0, 0x80, 0x41, 0x01, 0xC0, 0x80, 0x41, 0x00, 0xC1, 0x81, 0x40,
0x01, 0xC0, 0x80, 0x41, 0x00, 0xC1, 0x81, 0x40, 0x01, 0xC0, 0x80, 0x41, 0x01, 0xC0, 0x80, 0x41,
0x00, 0xC1, 0x81, 0x40, 0x01, 0xC0, 0x80, 0x41, 0x01, 0xC0, 0x80, 0x41, 0x00, 0xC1, 0x81, 0x40 };
```

Low-Order Byte Table

```
/* Table of CRC values for low-order byte */
static char auchCRCLo[] = {
0x00, 0xC0, 0xC1, 0x01, 0xC3, 0x03, 0x02, 0xC2, 0xC6, 0x06, 0x07, 0xC7, 0x05, 0xC5, 0xC4, 0x04,
0xCC, 0x0C, 0x0D, 0xCD, 0x0F, 0xCF, 0xCE, 0x0E, 0x0A, 0xCA, 0xCB, 0x0B, 0xC9, 0x09, 0x08, 0xC8,
0xD8, 0x18, 0x19, 0xD9, 0x1B, 0xDB, 0xDA, 0x1A, 0x1E, 0xDE, 0xDF, 0x1F, 0xDD, 0x1D, 0x1C, 0xDC,
0x14, 0x04, 0x05, 0x15, 0x07, 0x17, 0x16, 0x06, 0xD2, 0x12, 0x13, 0x03, 0x11, 0x01, 0xD0, 0x10,
0xF0, 0x30, 0x31, 0xF1, 0x33, 0xF3, 0xF2, 0x32, 0x36, 0xF6, 0xF7, 0x37, 0xF5, 0x35, 0xF4, 0x34,
0x3C, 0xFC, 0xFD, 0x3D, 0xFF, 0x3F, 0x3E, 0xFE, 0xFA, 0x3A, 0x3B, 0xFB, 0x39, 0xF9, 0xF8, 0x38,
0x28, 0xE8, 0xE9, 0x29, 0xEB, 0x2B, 0x2A, 0xEA, 0xEE, 0x2E, 0x2F, 0xEF, 0x2D, 0xED, 0xEC, 0x2C,
0xE4, 0x24, 0x25, 0xE5, 0x27, 0xE7, 0xE6, 0x26, 0x22, 0xE2, 0xE3, 0x23, 0xE1, 0x21, 0x20, 0xE0,
0xA0, 0x60, 0x61, 0xA1, 0x63, 0xA3, 0xA2, 0x62, 0x66, 0xA6, 0xA7, 0x67, 0xA5, 0x65, 0x64, 0xA4,
0x6C, 0xAC, 0xAD, 0x6D, 0xAF, 0x6F, 0x6E, 0xAE, 0xAA, 0x6A, 0x6B, 0xAB, 0x69, 0xA9, 0xA8, 0x68,
0x78, 0xB8, 0xB9, 0x79, 0xBB, 0x7B, 0x7A, 0xBA, 0xBE, 0x7E, 0x7F, 0xBF, 0x7D, 0xBD, 0xBC, 0x7C,
0xB4, 0x74, 0x75, 0xB5, 0x77, 0xB7, 0xB6, 0x76, 0x72, 0xB2, 0xB3, 0x73, 0xB1, 0x71, 0x70, 0xB0,
0x50, 0x90, 0x91, 0x51, 0x93, 0x53, 0x52, 0x92, 0x96, 0x56, 0x57, 0x97, 0x55, 0x95, 0x94, 0x54,
0x9C, 0x5C, 0x5D, 0x9D, 0x5F, 0x9F, 0x9E, 0x5E, 0x5A, 0x9A, 0x9B, 0x5B, 0x99, 0x59, 0x58, 0x98,
0x88, 0x48, 0x49, 0x89, 0x4B, 0x8B, 0x8A, 0x4A, 0x4E, 0x8E, 0x8F, 0x4F, 0x8D, 0x4D, 0x4C, 0x8C,
0x44, 0x84, 0x85, 0x45, 0x87, 0x47, 0x46, 0x86, 0x82, 0x42, 0x83, 0x41, 0x81, 0x40, 0x80, 0x40 };
```



ATTENTION

These devices must only be installed by a professional electrician, otherwise there is the risk of fire or the risk of an electric shock.



WARNING

Product is not intended to be used in safety critical applications, using it in safety critical applications is unsafe.



WARNING - Safety

The unit is not suitable for the explosion-proof areas and the areas of use excluded in EN 61010 Part 1.



WARNING - Safety

Check compliance with nominal voltage before commissioning the device (see type label). Check that connection cables are free from damage and that, when wiring up the device, they are not connected to voltage.



NOTE

In order to avoid moisture in the device due to condensate build-up, acclimatise the device at room temperature for about half an hour before connecting.



CLEANING

The device can be cleaned in dead state with a dry cloth or cloth soaked in soap solution. Do not use caustic or solvent-containing substances for cleaning.



MAINTENANCE

These devices are maintenance-free. If damaged during transportation or storage, no repairs should be undertaken by the user.



GUARANTEE

Opening the module invalidates the guarantee.



WEEE Directive 2012/19/EC Waste Electrical and Electronic Equipment directive

The product should not be disposed of with other household waste. Check for the nearest authorized collection centers or authorized recyclers. The correct disposal of end-of-life equipment will help prevent potential negative consequences for the environment and human health.



EAC Mark of Conformity for Machinery Exports to Russia, Kazakhstan or Belarus.



PCD1.W5200-A20

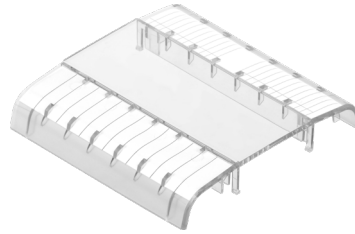

PCD1.K0206-005

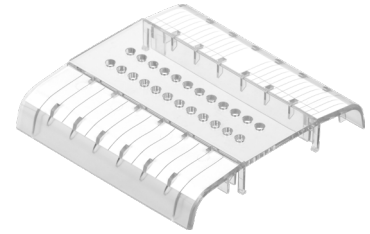

PCD1.K0206-025



Terminal set
32304321-003-S

Order details

Type	Short description	Description	Weight
PCD1.W5200-A20	E-Line S-Serie RIO 8AO	E-Line S-Serie analogue output module manual override operating level for all outputs status LED for outputs supply 24 VDC 8 analogue outputs 10 bits, 0...10 V 1 interface RS-485 (S-Bus and Modbus) 1 USB service interface	200 g
PCD1.K0206-005	E-Line labelling set 5 × 6 HP*	E-Line cover and labelling set consisting of 5 × covers (6 HP = 105 mm) and labelling sheet for mounting in the automation control cabinet	365 g
PCD1.K0206-025	E-Line labelling set 5 × 6 HP* with holes	E-Line cover and labelling set with holes consisting of 5 × covers (6 HP = 105 mm) with holes for manual override operating level and labelling sheet for mounting in the automation control cabinet	365 g
32304321-003-S	Terminal set	6-pin terminal. Set of 6 terminal blocks	40 g

* Horizontal pitch: 1 HP corresponds to 17.5 mm

Saia-Burgess Controls AG

Bahnhofstrasse 18 | 3280 Murten, Switzerland
T +41 26 580 30 00 | F +41 26 580 34 99
www.saia-pcd.com

support@saia-pcd.com | www.sbc-support.com